

---

# **QMS<sup>®</sup> CrownNet<sup>®</sup> System Administrator's Guide**

---

**1800393-001G**



## **Trademarks**

The following are trademarks or registered trademarks of their respective owners. Other product names mentioned in this manual may also be trademarks or registered trademarks of their respective owners. Registered trademarks are registered in the United States Patent and Trademark Office; some trademarks may also be registered in other countries. QMS, Crown, CrownNet, the Crown seal, and the QMS logo are registered trademarks of QMS, Inc. Adobe, Acrobat and Illustrator/Adobe Systems Incorporated. PostScript is a trademark of Adobe Systems Incorporated for a page description language and may be registered in certain jurisdictions. Apple, AppleTalk, EtherTalk, LaserWriter, LocalTalk, Macintosh, TrueType/Apple Computer, Inc. DEC, DECnet, VMS/Digital Equipment Corporation. FrameMaker/Frame Technology Corporation. Hewlett-Packard, HP, PCL, HP-GL, HP-UX, LaserJet/Hewlett-Packard Co. AIX, IBM PC, Token-Ring/International Business Machines Corporation. Helvetica/Linotype-Hell AG and/or its subsidiaries. Internet Explorer, Microsoft, MS-DOS/Microsoft Corporation. Netscape/Netscape, Inc. Novell, Novell YES, and NetWare/Novell, Inc. Transverter Pro/TechPool, Inc. UNIX/UNIX Systems Laboratories. Ethernet, Xerox/Xerox Corporation. ITC Zapf Dingbats/International Typeface Corporation. Solaris, SunOS/Sun.

## **Proprietary Statement**

The software included with your CrownNet interface is Copyrighted © 1998 by QMS, Inc. All Rights Reserved. This software may not be reproduced, modified, displayed, transferred, or copied in any form or in any manner or on any media, in whole or in part, without the express written permission of QMS, Inc.

## **Copyright Notice**

This manual is Copyrighted © 1998 by QMS, Inc., One Magnum Pass, Mobile, AL 36618. All Rights Reserved. This manual may not be copied in whole or in part, nor transferred to any other media or language, without the express written permission of QMS, Inc.

## **Colophon**

This manual was written and formatted in FrameMaker. The illustrations were created in Adobe Illustrator and translated to WMF format in Transverter Pro. Typefaces used are Benguiat, Courier, Helvetica, Symbol, and ITC Zapf Dingbats.

---

---

# Contents

---

## 1 Introduction

<b>Introduction</b> .....	<b>1-2</b>
<b>About the Documentation</b> .....	<b>1-3</b>
Standard Product Documentation	1-3
Other Relevant Documentation	1-4
About This Manual	1-5
<b>Typographic Conventions</b> .....	<b>1-7</b>

---

# 2 Printer Interface Configuration

<b>Introduction .....</b>	<b>2-2</b>
<b>Changing Configuration Settings .....</b>	<b>2-2</b>
The CrownNet Menu	2-3
<b>Configuring Network Interface Characteristics .....</b>	<b>2-4</b>
Enabling the CrownNet Interface	2-4
Selecting a Default Emulation	2-5
Setting the Spool Buffer Size	2-5
Default Job Priority	2-7
PS Protocol	2-8
<b>Configuring Common Interface Characteristics .....</b>	<b>2-9</b>
Selecting Spooling Options	2-10
Setting the Hardware Address	2-11
Printing a Configuration Page	2-12
Resetting Factory Defaults	2-12
Using a Soft Reset	2-13
Setting the Token-Ring Speed	2-13
Identifying Source Routing	2-14
Setting Ethernet Speed	2-17
<b>Configuring the EtherTalk Protocol .....</b>	<b>2-18</b>
Enabling the EtherTalk Protocol	2-18
Identifying Network Settings	2-19
Identifying the Type of Connection	2-21
Setting the EtherTalk Zone	2-23
<b>Configuring the OS/2 LAN Manager/LAN Server or Microsoft Windows Protocol .....</b>	<b>2-24</b>
Enabling the OS/2 LAN Manager/LAN Server or Microsoft Windows Network Protocol	2-25
Naming the Printer	2-25
Resetting the Printer Name	2-26
<b>Configuring the NetWare Protocol .....</b>	<b>2-27</b>
About the CrownNet Security Feature	2-27
Enabling the NetWare Protocol	2-29
Configuring the Print Server	2-29
Configuring the Remote/Network Printers	2-37

Specifying a Printer Name	2-40
Setting the Frame Type	2-42
<b>Configuring the TCP/IP Protocol</b>	<b>2-45</b>
Enabling the TCP/IP Protocol	2-46
Setting the Internet Address	2-47
Setting the Subnet Mask	2-48
Setting the Default Router Address	2-49
Deleting the FTP Password File	2-50
Deleting the Host Files	2-50
Blocking Access to Printer Files	2-51
Enabling TCP/IP Accounting and Reverse Channel Communications	2-51
Setting an Accounting Timeout	2-52
Assigning a TCP/IP Port	2-53
Printing an LPD Banner Page	2-54
Disabling the BOOTP Protocol	2-54
Disabling the RARP Protocol	2-55
Configuring SNMP Information	2-55
<b>Setting the Binary Communications Protocol</b>	<b>2-58</b>
Quoting Mechanism	2-60
Advantages	2-61
Implementation	2-61
<b>Setting the Default Job Priority</b>	<b>2-62</b>

## **3 CrownAdmin for DOS**

<b>Introduction</b>	<b>3-2</b>
<b>Opening CrownAdmin</b>	<b>3-2</b>
<b>Using Remote Console</b>	<b>3-2</b>
Accessing Remote Console	3-2
Multiple Remote Console Sessions	3-3
Closing a Remote Console Session	3-3
<b>Closing CrownAdmin</b>	<b>3-4</b>

# 4 CrownAdmin 3

<b>Introduction .....</b>	<b>4-2</b>
<b>About CrownAdmin 3 .....</b>	<b>4-3</b>
<b>Opening CrownAdmin 3 .....</b>	<b>4-3</b>
Windows 95, and Windows NT 4-4	
Solaris/SunOS, AIX, and HP-UX 4-4	
OS/2 4-4	
Macintosh 4-4	
<b>Using the Online User's Guide .....</b>	<b>4-8</b>
Accessing the Online User's Guide 4-8	
Finding Information in the On-Line User's Guide 4-8	
Viewing Multiple Help Topics 4-8	
<b>Configuring the Interface and the Printer .....</b>	<b>4-9</b>
Configuration Buttons 4-9	
<b>Using Remote Console .....</b>	<b>4-13</b>
Accessing Remote Console 4-13	
Multiple Remote Console Sessions 4-14	
Closing a Remote Console Session 4-14	
<b>Closing CrownAdmin 3 .....</b>	<b>4-14</b>

# 5 CrownNet Manager for OS/2

<b>Introduction .....</b>	<b>5-2</b>
Overview of CrownNet Manager for OS/2 5-2	
Printing Directly to the Printer 5-3	
<b>Opening CrownNet Manager for OS/2 .....</b>	<b>5-3</b>
<b>Using CrownNet Manager .....</b>	<b>5-4</b>
Using the Help Menu 5-4	
Using the Install Menu 5-5	
Using the Logfile Menu 5-5	
Using the Remove Menu 5-6	
Using the Status Menu 5-6	
<b>Closing CrownNet Manager .....</b>	<b>5-8</b>

Additional Technical Notes .....5-8

## **6 CrownNet Print Utility for Windows: Microsoft Windows Network Support**

**Introduction** .....6-2  
    Requirements 6-2  
    Installation 6-2

**Setting Up Serverless Printing** .....6-3

**Setting Up Client-Server (Server-Based) Printing** .....6-3  
    Notify Option 6-3  
    Refresh Option 6-4

**Getting Help** .....6-4

## **7 UNIX Utilities**

**Introduction** .....7-2

**Setting the Internet Address** .....7-2  
    The bootp Protocol 7-3  
    The rarp Protocol 7-4

**QMS qpr Command** .....7-5  
    Syntax 7-5  
    Options 7-5  
    Notes 7-8

**FTP (File Transfer Protocol)** .....7-8  
    Supported FTP Commands 7-9  
    Logging in to a Printer via FTP 7-10  
    Exiting from a Printer via FTP 7-11

**Password Files** .....7-11  
    Logging In with a Password 7-13  
    Listing the Contents of the Password File 7-14

**Host Address Files** .....7-14

Listing the Contents of the Host Address File	7-16
<b>Directory Commands</b>	<b>7-16</b>
Displaying the Current Directory (pwd)	7-16
Changing Directories (cd)	7-17
Listing the Contents of a Directory (dir)	7-17
<b>Printer Directories</b>	<b>7-17</b>
ADMIN Directory	7-18
DISK Directory	7-18
HELP Directory	7-18
NO_DOC_CMDS Directory	7-19
USR Directory	7-20
<b>Printing and Transferring Files</b>	<b>7-21</b>
type Command	7-21
put and mput Commands	7-22
get Command	7-23
<b>QMS LPD (Line Printer Daemon)</b>	<b>7-24</b>
Configuring the Host to Use the QMS LPD	7-24
Using LPD	7-26
Monitoring Status	7-26
<b>HP-UX Versions 9.x and 10.x</b>	<b>7-27</b>

## 8 Printer Web Page

<b>Introduction</b>	<b>8-2</b>
<b>Using the Printer Web Page</b>	<b>8-2</b>
Assigning a Printer Name	8-2
Setting Up Your Browser Software	8-3
<b>Types of Printer Web Pages</b>	<b>8-3</b>
Home Page	8-4
Operator Control Page	8-5
General Settings Page	8-6
Printer Jobs Page	8-7
Consumable Status Page	8-8
Accounting Page	8-9
System Support Page	8-10
QMS, Inc. Page	8-11
Online Help Page	8-12



<b>Web Page Help System .....</b>	<b>8-13</b>
<b>Email Notification on Printer Error .....</b>	<b>8-14</b>
Configuration 8-14	

## **9 Troubleshooting**

<b>Introduction .....</b>	<b>9-2</b>
<b>General Problems .....</b>	<b>9-2</b>
<b>CrownAdmin for DOS Problems .....</b>	<b>9-3</b>
<b>CrownAdmin3forWindows,Solaris/SunOS,AIX,andHP-UXProblems 9-4</b>	
<b>EtherTalk Problems .....</b>	<b>9-5</b>
<b>OS/2 LAN Manager/LAN Server Problems .....</b>	<b>9-7</b>
<b>NetWare Problems .....</b>	<b>9-8</b>
<b>TCP/IP Problems .....</b>	<b>9-12</b>
All UNIX Systems 9-12	
BSD UNIX Systems 9-12	
SYS V UNIX Systems 9-13	
<b>Updating CrownNet Software .....</b>	<b>9-13</b>
System Requirements 9-14	
Before You Begin Downloading the Software 9-14	
Downloading the Software 9-15	

## **A QMS Customer Support**

<b>Sources of Support .....</b>	<b>A-2</b>
Your QMS Vendor A-2	
Your Application Vendor A-2	
Q-FAX A-2	
CompuServe A-3	
Internet A-3	
QMS Customer Response Center (CRC) A-3	
<b>QMS World-wide Offices .....</b>	<b>A-5</b>

# B Technical Specifications

<b>CrownNet Specifications</b> .....	<b>B-2</b>
Features B-2	
Networks and Protocols B-3	
Network Attachments B-3	
Network Speed—Token-Ring B-3	
<b>EtherTalk Specifications</b> .....	<b>B-4</b>
Connections B-4	
Features B-4	
Protocols B-4	
<b>OS/2 LAN Manager/LAN Server Specifications</b> .....	<b>B-5</b>
Connections B-5	
OS/2 Features B-5	
<b>Microsoft Windows Network Features</b> .....	<b>B-6</b>
Protocols B-6	
<b>NetWare Specifications</b> .....	<b>B-6</b>
Bindery Connections B-6	
NDS Connections B-7	
Features B-7	
Protocols B-8	
<b>TCP/IP Specifications</b> .....	<b>B-8</b>
Connections B-8	
Features B-8	
FTP B-9	
Protocols B-9	
SNMP B-10	
Telnet B-10	

# C SNMP and TCP/IP Concepts

<b>Introduction</b> .....	<b>C-2</b>
<b>SNMP</b> .....	<b>C-2</b>
Traps C-2	
Communities and Community Names C-3	
QMS-Specific Management Information Base (MIB) C-3	
Changing Printer Configuration via SNMP C-4	

<b>TCP/IP .....</b>	<b>C-5</b>
Subnetting C-5	
Internet Routing C-6	
Class A, B, and C Internet Addresses C-7	
<b>TCP/IP Accounting and Reverse Channel .....</b>	<b>C-8</b>
The qef Command C-8	
Accounting Information Format C-10	
Reverse Channel Information Format C-13	
Spooling C-14	
Accounting Packet Format C-14	
Reverse Channel Packet Format C-15	

## **D CrownNet Menus**

<b>Introduction .....</b>	<b>D-2</b>
Entering the CrownNet Menu D-2	
Common Menu D-3	
EtherTalk Menu D-4	
Lan Manager Menu D-5	
NetWare Menu D-6	
TCP/IP Menu D-7	

## **Glossary**

## **Index**





# 1

---

## Introduction

---

### **In This Chapter . . .**

- “About the Documentation” on page 1-3
  - “About This Manual” on page 1-5
  - “Typographic Conventions” on page 1-7
-

# Introduction

QMS CrownNet is a combination of a network interface and host software that together allow your QMS Crown printer to be connected to either an Ethernet or a Token-Ring network:

- **CrownNet Ethernet interfaces** are either built into the print system—as on the QMS 2425, 2060, and 4060 Print Systems—or available as an optional network interface card (NIC).
- **CrownNet Token-Ring interfaces** are available only as an optional network interface card (NIC).

The CrownNet interface supports the following:





<b>Operating System/Protocol</b>	<b>Ethernet Networks</b>	<b>Token-Ring Networks</b>
AppleTalk (EtherTalk)	✓	
LAN Manager/LAN Server (NetBIOS/NetBEUI)	✓	✓
NetWare (IPX/SPX)	✓	✓
TCP/IP	✓	✓

For complete specifications, see appendix B, “Technical Specifications.”

# About the Documentation

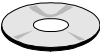
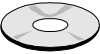
## Standard Product Documentation

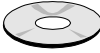
You received the following documentation with your product:

	<b>QMS CrownNet System Administrator's Manual</b>	The manual that you are reading now. See "About This Manual," later in this section, for more information about the contents of this manual.
	<b>QMS CrownNet Setup Guide</b>	You'll need to refer to this guide if you're setting up the CrownNet network interface card (NIC) or loading the software utilities. This guide is in portable document format (PDF) on the Software Utilities CD-ROM.
	<b>QMS Crown Remote Console User's Guide</b>	This manual describes how to use the Remote Console software to access printer information and change printer configuration from anywhere on the network. This guide is in PDF on the <i>QMS Software Utilities</i> CD-ROM.
	<b>QMS Network Print Monitor for Windows 95 Administrator's Guide</b>	This manual describes how to install and use the QMS Print Monitor for Windows 95. This utility is designed for QMS Crown printers using TCP/IP protocol.
	<b>QMS Network Print Monitor for Windows NT Administrator's Guide</b>	This manual describes how to install and use the QMS Print Monitor for Windows NT. This utility is designed for QMS Crown printers using TCP/IP protocol.

## About the Documentation

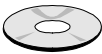
	<b>CrownAdmin online help</b>	Online help is provided for CrownAdmin 3 in the Windows, AIX, HP-UX, Solaris, SunOS, Macintosh, and OS/2 environments. It is installed when you install the CrownNet software, using the instructions in the <i>QMS CrownNet Setup Guide</i> . See chapter 4, "CrownAdmin 3," in this manual for information on accessing and using the online help.
---	-------------------------------	--

## Other Relevant Documentation

In addition to the standard product documentation listed above, you'll need the following:

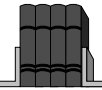
	<b>Your printer documentation</b>	If you're installing an optional CrownNet NIC, use the installation instructions provided here. If no instructions are given, you must contact a QMS service technician for installation. The printer documentation also explains how to use the printer control panel to make configuration menu changes.
	<b>Your application, host operating system, and network documentation</b>	This documentation contains useful printing information.



## **About This Manual**

This manual guides you through configuring the CrownNet interface and using the CrownAdmin, CrownAdmin 3, CrownNet Manager, CrownNet Print Utility for Windows, and UNIX host software. Information is organized in the following sections:

<b>1</b>	<b>Introduction</b>	Provides an overview of the CrownNet interface and describes the documentation.
<b>2</b>	<b>Printer Configuration</b>	Briefly explains the two methods of interface configuration—the printer control panel and remote console—and then explains each of the configuration options in detail.
<b>3</b>	<b>CrownAdmin for DOS</b>	Explains how to use the CrownAdmin software on DOS systems to access Remote Console.
<b>4</b>	<b>CrownAdmin 3</b>	Provides an overview of CrownAdmin 3 and explains how to access and use the on-line user's guide. Explains how to use the CrownAdmin software and access Remote Console.
<b>5</b>	<b>CrownNet Manager for OS/2</b>	Explains how to use CrownNet Manager for OS/2 to monitor and customize your OS/2 printing environment.
<b>6</b>	<b>CrownNet Print Utility for Windows</b>	Describes how to set up the QMS CrownNet Print Utility for Windows and how to access on-line help.
<b>7</b>	<b>UNIX Utilities</b>	Lists the supported varieties of UNIX, identifies the main differences between HP-UX Versions 9.x and 10.x, and discusses the BOOTP and RARP protocols, QMS <b>qpr</b> command, supported FTP commands, and QMS LPD.

---

<b>8</b>	<b>Printer Web Page</b>	Describes how to read and set up the printer web page.
<b>9</b>	<b>Troubleshooting</b>	Describes common problems with network printing and suggests solutions to these problems/errors.
<b>A</b>	<b>QMS Customer Support</b>	Provides world-wide product sales and support telephone numbers and describes how to communicate with QMS through CompuServe, the Internet, and Q-FAX.
<b>B</b>	<b>Technical Specifications</b>	Provides technical specifications on the QMS CrownNet NIC.
<b>C</b>	<b>SNMP and TCP/IP Concepts</b>	Discusses SNMP, TCP/IP, and TCP/IP accounting/reverse channel concepts.
<b>D</b>	<b>CrownNet Menus</b>	Contains flowcharts of the CrownNet menus for you to reference as you configure the interface.
	<b>Glossary</b>	Defines key networking terms.
	<b>Index</b>	

---

# Typographic Conventions

The following typographic conventions are used throughout this manual:

Mixed-Case Courier	Text you type, and messages and information displayed on the screen; in interactive examples, text you type is in bold mixed-case Courier
<i>Mixed-Case Italic Courier</i>	Variable text you type; replace the italicized word(s) with information specific to your printer or computer
<b>lowercase bold</b>	Commands
<i>lowercase italic</i>	Variable information in text
UPPERCASE	File and utility names
↵	Press the Enter key (PC) or Return key (Macintosh)

» **Note:** *Notes contain tips, extra information, or important information that deserves emphasis or reiteration.*

---

▲ **Caution:** *Cautions present information that you need to know to avoid equipment damage, process failure, or extreme annoyance.*

---

💣 **WARNING!** *Warnings indicate the possibility of personal injury if a specific procedure is not performed exactly as described in the manual.*

**ACHTUNG!** *Bitte halten Sie sich exakt an die im Handbuch beschriebene Vorgehensweise, da sonst Verletzungsgefahr bestehen könnte.*

---





# 2

---

## Printer Interface Configuration

---

### In This Chapter...

- “Changing Configuration Settings” on page 2-2
  - “Configuring Network Interface Characteristics” on page 2-4
  - “Configuring Common Interface Characteristics” on page 2-9
  - “Configuring the EtherTalk Protocol” on page 2-18
  - “Configuring the OS/2 LAN Manager/LAN Server or Microsoft Windows Protocol” on page 2-25
  - “Configuring the NetWare Protocol” on page 2-28
  - “Configuring the TCP/IP Protocol” on page 2-46
-

# Introduction

The chapter briefly introduces the methods of interface configuration and then explains each of the configuration options in detail.

- » **Note:** *If you've purchased an optional CrownNet NIC, it must be installed in the printer before the interface can be configured. Refer to your printer user's guide for installation instructions. If no instructions are given, you must contact a QMS service technician for installation. To find a QMS service technician near you, contact your QMS vendor or call QMS Product Support. See appendix A, "QMS Customer Support," for a list of QMS world-wide service and support offices.*

## Changing Configuration Settings

You can change the CrownNet interface configuration settings in the following ways:

- **CrownAdmin**

CrownAdmin is available for DOS. See the chapter 3 in this manual for more information.

- **CrownAdmin 3**

CrownAdmin 3 is available for AIX, HP-UX, Solaris, SunOS, and Windows/Windows NT/Windows 95, OS/2, and Macintosh environments. See the chapter 4 in this manual for more information.

- **Printer control panel**

For complete information on using the control panel to make configuration changes, see your printer documentation.

### ■ Remote Console or Local Console

For information on accessing Remote Console, see the online help in CrownAdmin 3. For information on using Remote or Local Console, see the *QMS Crown Remote Console User's Guide*.

### ■ Printer Web Page

For information on setting up and configuring the printer web page, see "Printer Web Page" on page 2-1 in this manual or your printer documentation.

## The CrownNet Menu

Use the Administration/Communications/xxxxxxx NIC/CrownNet menu to configure the CrownNet interface (where xxxxxxxx is either Resident or Optional). This menu has five submenus:

- **Common**—Use this menu to configure features common to all four interfaces.
- **EtherTalk**—Use this menu to configure the EtherTalk interface (Ethernet networks only).
- **LAN Manager**—Use this menu to configure the OS/2 LAN Manager/LAN Server interface or the Microsoft Windows Network interface.
- **NetWare**—Use this menu to configure the NetWare interface.
- **TCP/IP**—Use this menu to configure the TCP/IP interface.

This chapter explains the configuration options available in each of these menus. See "CrownNet Menus" in Appendix D for menu flowcharts.

# Configuring Network Interface Characteristics

This section describes in detail the configuration options available in the Administration/Communications/xxxxxxx NIC menu (where xxxxxxxx is either Resident or Optional):

- **Mode**—Allows you to control how print jobs accepted over the CrownNet interface are spooled and sent to the printer.
- **Emulation**—Allows you to choose the emulation used for your print jobs.
- **Min[imum] K[ilobyte] Spool**—Allows you to define the size of the job spooling buffer allocated to the CrownNet interface.
- **Def[ault] Job Prio[rity]**—Allows you to specify which jobs are printed first, according to the interface through which they are received, when jobs are received simultaneously.
- **PS Protocol**—Allows you to set the binary communications protocol (BCP) for communicating over a parallel interface to a Post-Script printer.

## Enabling the CrownNet Interface

The **Mode** menu allows you to enable or disable network communication over the CrownNet interface. This ability is useful if you're not planning to use the interface. By disabling it, the memory used by the interface spooler can be allocated to other memory clients.

<b>Menu</b>	Administration/Communications/Resident NIC/Mode Administration/Communications/Optional NIC/Mode
<b>Choices</b>	<b>Enabled</b> —Enables the printer to accept print jobs over the interface. <b>Disabled</b> —Disables the printer from accepting print jobs over the interface.
<b>Default</b>	Enabled
<b>Note</b>	Mode can appear under the Common menu on some printers



## Selecting a Default Emulation

Use the Emulation menu to select the default emulation (from those installed on the printer) for print jobs received over the interface.

<b>Menu</b>	Administration/Communications/Resident NIC/Emulation Administration/Communications/Optional NIC/Emulation
<b>Typical Choices</b>	<p><b>CCITT</b>—CCITT Groups 3 and 4 emulation.</p> <p><b>ESP</b>—Emulation Sensing Processor technology. Using a form of artificial intelligence, ESP technology analyzes incoming file data from the interface and determines which emulation, from those installed on the printer, to use to print the job.</p> <p><b>Hexdump</b>—Hexdump. This emulation prints the hexadecimal values of all non-protocol bytes (those that are part of the original file) received over the interface.</p> <p><b>HPGL</b>—HP-GL emulation.</p> <p><b>Lineprinter</b>—Line printer output.</p> <p><b>LN03+</b>—DEC LN03 Plus emulation.</p> <p><b>PCL4</b>—HP PCL 4 emulation.</p> <p><b>PCL5</b>—HP PCL 5 emulation.</p> <p><b>PostScript</b>—PostScript Level 1 and Level 2 emulations.</p> <p><b>QUIC II</b>—QMS QUIC II language.</p>
<b>Default</b>	Printer-dependent; however, the typical default is ESP.
<b>Effectivity</b>	Changes take effect on the next print job.
<b>Notes</b>	Choices in this menu are printer-dependent. Those listed above are only typical choices. Emulation can appear under the Common menu on some printers.

## **Setting the Spool Buffer Size**

Use the Min K Spool menu to define the size of the job spooling buffer allocated to the interface. Min K Spool is the minimum number of kilobytes of the spool buffer (both RAM and optional disk) allocated to data received via the interface.

<b>Menu</b>	Administration/Communications/Resident NIC/Min K Spool Administration/Communications/Optional NIC/Min K Spool
<b>Choices</b>	Printer-dependent
<b>Default</b>	Printer-dependent
<b>Notes</b>	<p>A zero for spool space does not turn an interface off. If an interface is not to be used, disable it [Administration/Communications/xxxxxxx NIC/CrownNet/<i>Interface</i>/Protocol menu (where xxxxxxxx is either Resident or Optional)] so memory assigned to it will be assigned to the other protocols.</p> <p>The sum of Min K Spool settings for all of the installed communications interfaces must be less than or equal to the setting in the Administration/Communications/K Mem for Spool menu. If Min K Spool is set to zero, the system automatically calculates a new value for it (½ of that available in K Mem for Spool) each time the printer is turned on.</p> <p>If the sum of the Min K Spool settings for all installed interfaces is less than the setting of K Mem for Spool, the remaining space is considered float memory, memory that can be allocated as necessary. When an interface has used its default allotment, it may use any available float memory to spool additional data. The float memory is allocated on a first-come, first-served basis. No interface is guaranteed access to any spool buffer beyond its Min K Spool value.</p> <p>Min K Spool can appear under the Common menu on some printers.</p>

## **Default Job Priority**

Allows you to specify which jobs are printed first, according to the interface through which they are received, when jobs are received simultaneously.

<b>Menu</b>	Administration/Communications/Resident NIC/Def Job Prio Administration/Communications/Optional NIC/Def Job Prio
<b>Choices</b>	001-100 (lowest - highest priority)
<b>Default</b>	001
<b>Notes</b>	For example, you can give jobs received via the Ethernet interface priority over jobs received via the parallel and serial interfaces.

## **PS Protocol**

Sets the binary communications protocol (BCP) for communicating over a CrownNet 2 interface to a PostScript printer.

<b>Menu</b>	Administration/Communications/Resident NIC/PS Protocol Administration/Communications/Optional NIC/PS Protocol
<b>Choices</b>	<p>Normal—Enables standard, ASCII (7-bit) hex protocol. Data is sent and received in ASCII format. This mode is recommended if you do not print binary data. It was designed for data in the printable ASCII range. Print jobs can change this setting through PostScript operators.</p> <p>Normal Fixed—Enables standard, ASCII (7-bit) hex protocol. Print jobs cannot change this setting through PostScript operators.</p> <p>Binary—Enables quoted binary communications protocol (BCP). Print jobs can change this setting through PostScript operators. Data in the printable ASCII range also prints. Use the special quoting mechanism (see the following section) for the special characters and ^D (EOF).</p> <p>Binary provides only raw data, not quoted BCP, over the CrownNet interface.</p> <p>Binary Fixed—Enables binary communications protocol (BCP). Print jobs cannot change this setting through PostScript operators. Data in the printable ASCII range also prints. Use the special quoting mechanism (see the following section) for the special characters and ^D (EOF).</p> <p>Binary provides only raw data, not quoted BCP, over the CrownNet interface.</p> <p>QBinary (Quoted Binary)—Enables quoted binary communications protocol. Print jobs can change this setting through PostScript operators. Data in the printable ASCII range also prints.</p> <p>QBinary Fixed—Enables quoted binary communications protocol (BCP). Print jobs cannot alter change this setting through PostScript operators. Data in the printable ASCII range also prints.</p>
<b>Default</b>	Normal

# Configuring Common Interface Characteristics

This section describes in detail the configuration options available in the Administration/Communications/xxxxxxx NIC/CrownNet/Common menu (where xxxxxxxx is either Resident or Optional):

- **Spooling**—Allows you to control how print jobs accepted over the CrownNet interface are spooled and sent to the printer.
- **H[ard]W[are] Address**—Allows you to override the factory-default hardware address.
- **Config[uration] Page**—Allows you to print the CrownNet interface's internally generated configuration page.
- **Factory Reset**—Allows you to reset all the CrownNet configuration settings (except the hardware and Internet address) to their factory defaults.
- **Soft Reset**—Allows you to reset the CrownNet interface.
- **Ring Speed** (Token-Ring networks only)—Allows you to select the Token-Ring network speed.
- **Source Routing** (Token-Ring networks only)—Allows you to identify the source routing type to be used.
- **Ethernet Speed**—Allows you to select the Ethernet network speed.

## Selecting Spooling Options

Crown technology allows QMS Crown printers to accept data simultaneously over all available interface ports. The Administration/Communications/xxxxxxx NIC/CrownNet/Common/Spooling menu (where xxxxxxxx is either Resident or Optional) allows you to control how print jobs accepted over the CrownNet interface are spooled and sent to the printer.

<b>Menu</b>	Administration/Communications/Resident NIC/CrownNet/ Common/Spooling Administration/Communications/Optional NIC/CrownNet/ Common/Spooling
<b>Choices</b>	<p><b>On</b>—Print jobs are accepted, spooled to memory, and sent to the printer controller for printing as soon as it will accept them. Therefore, several print jobs may be considered active at one time.</p> <p><b>On Idle</b>—Print jobs are spooled to memory when the printer is idle (all pages of the previous print job have been printed). Therefore, only a single print job is active at one time.</p> <p><b>On Input Idle</b>—Print jobs are accepted and spooled to memory when all pages from the previous job have been input. This means that the printer controller has finished compiling the previous print job, but not all of the pages have necessarily been printed.</p>
<b>Default</b>	On Input Idle
<b>Effectivity</b>	Changes take effect as soon as you put the printer back on line.
<b>Notes</b>	Choosing either On or On Input Idle automatically sets the Mode option in the Administration/Communications/xxxxxxx NIC/CrownNet/TCPIP/Accting/Revchan menu (where xxxxxxxx is either Resident or Optional) to Disabled, thus disabling TCP/IP accounting.

## **Setting the Hardware Address**

The HW Address menu allows you to override the factory-default hardware address.

<b>Menu</b>	Administration/Communications/Resident NIC/CrownNet/ Common/HW Address Administration/Communications/Optional NIC/CrownNet/ Common/HW Address
<b>Choices</b>	00000000-7FFFFFFF
<b>Default</b>	FFFFFFFF
<b>Effectivity</b>	The CrownNet interface must be reset for changes to take effect. Use the Administration/Communications/xxxxxxx NIC/ CrownNet/Common/Soft Reset menu (where xxxxxxxx is either Resident or Optional).
<b>Notes</b>	<p>The hardware address is printed on the printer's start-up page.</p> <p>If the HW Address value is the default FFFFFFFF, the physical address is the QMS S/N 080086xxxxxx for Ethernet or 100061xxxxxx for Token-Ring.</p> <p>Ethernet addresses begin with "0200." These numbers are not displayed on the printer control panel, and they may not be changed. For example, if the HW Address is set to 12341234, the physical Ethernet address of the printer is actually 020012341234.</p> <p>Token-Ring addresses begin with "1000". These numbers are not displayed on the printer control panel. When the address is changed from the default, the Token-Ring address begins with "4000" For example, if HW Address is set to 43214321, the Token-Ring hardware address of the printer will be 400043214321.</p>

## **Printing a Configuration Page**

The Config Page menu allows you to print the QMS CrownNet interface's internally generated configuration pages. These pages include information on the configuration of all protocols on the CrownNet interface.

<b>Menu</b>	Administration/Communications/Resident NIC/CrownNet/Common/Config Page Administration/Communications/Optional NIC/CrownNet/Common/Config Page
<b>Choices</b>	<b>No</b> —Does not print a configuration page. <b>Yes</b> —Prints a configuration page.
<b>Default</b>	No
<b>Effectivity</b>	The status page is sent to the print engine as soon as the printer is put back on line. You must put the printer back on line within 20 seconds after selecting a configuration page.

## **Resetting Factory Defaults**

The Factory Reset menu allows you to reset all QMS CrownNet interface configuration settings (except the Internet and HW addresses) to their factory default values.

<b>Menu</b>	Administration/Communications/Resident NIC/CrownNet/Common/Factory Reset Administration/Communications/Optional NIC/CrownNet/Common/Factory Reset
<b>Choices</b>	<b>No</b> —Does not reset all configuration settings to their factory default. <b>Yes</b> —Resets all configuration settings to their factory default.
<b>Default</b>	No
<b>Effectivity</b>	The CrownNet interface must be reset for changes to take effect. Use the Administration/Communications/xxxxxxx NIC/CrownNet/Common/Soft Reset menu (where xxxxxxxx is either Resident or Optional).



<b>Notes</b>	Choosing Yes resets only the CrownNet interface configuration settings to their factory default. It does not reset the whole printer configuration menu.  The Internet and HW addresses are not changed.
--------------	--

## Using a Soft Reset

The Soft Reset menu allows you to reset the QMS CrownNet interface (not the entire printer). It is used to put certain CrownNet interface configuration changes into effect.

<b>Menu</b>	Administration/Communications/Resident NIC/CrownNet/Common/Soft Reset Administration/Communications/Optional NIC/CrownNet/Common/Soft Reset
<b>Choices</b>	<b>No</b> —Does not reset the CrownNet interface. <b>Yes</b> —Resets the CrownNet interface.
<b>Default</b>	No
<b>Effectivity</b>	Changes to this menu take effect as soon as the printer goes idle.
<b>Notes</b>	Make sure that you have set up a printer name under the interface menu before you do a soft reset.

## Setting the Token-Ring Speed

The Ring Speed menu allows you to select the speed of the Token-Ring interface.

» **Note:** *This menu is applicable to Token-Ring configuration only.*

<b>Menu</b>	Administration/Communications/Resident NIC/CrownNet/Common/Ring Speed Administration/Communications/Optional NIC/CrownNet/Common/Ring Speed
<b>Choices</b>	4 Mbit/Sec 16 Mbit/Sec

## Configuring Common Interface Characteristics

<b>Default</b>	16 Mbit/Sec
<b>Effectivity</b>	The CrownNet interface must be reset for changes to take effect. Use the Administration/Communications/xxxxxxx NIC/CrownNet/Common/Soft Reset menu (where xxxxxxxx is either Resident or Optional).
<b>Notes</b>	This cannot be configured from CrownAdmin 3 unless you use remote console.  Make sure that you disconnect the printer from the network before you change the ring speed.

## Identifying Source Routing

The Source Routing menu allows you to identify the default type of source routing broadcast information in outgoing frames. It is used when a previous route cannot be found in the source routing table.

- » **Note:** *This menu is applicable to Token-Ring configuration only.*

<b>Menu</b>	Administration/Communications/Resident NIC/CrownNet/Common/Source Routing Administration/Communications/Optional NIC/CrownNet/Common/Source Routing
<b>Choices</b>	<b>All</b> —Send as an all-routes-explorer frame, also known as an all-routes-broadcast frame.  This setting is useful if your network doesn't have a spanning tree, where frames can be exchanged using single-route-broadcast frames, or if large amounts of data are being transmitted and the spanning tree offers a nonsatisfactory route. This setting creates a higher network load than either Auto or Single in the route determination phase, but it is more likely to result in the best choice of route.

## Configuring Common Interface Characteristics

**Auto**—Send as the most appropriate frame type, based on the entries in the SAP route-guess table. (See “SAP Route-Guess Table,” later in this section, for more information.)

This setting is useful for most environments. However, under certain circumstances (such as an extremely heavy network load, network source routing policies, or an obscure mixture of servers using different source routing types at the same SAP) you may need to switch to one of the other settings.

**Off**—Send without source routing information.

This setting is useful in strictly “transparent bridge” environments or with old equipment that doesn’t support source routing. Received frames with route information are still answered along that specific route, but when the source routing table entry times out, the route cannot be rediscovered from the CrownNet interface.

**Single**—Send as a spanning-tree-explorer frame, also known as a single-route-broadcast frame.

This setting is useful in environments where there are no “transparent bridges” and where a spanning tree protocol is successfully used by the Token-Ring bridges.

<b>Default</b>	Auto
<b>Effectivity</b>	Changes to this menu take effect as soon as the printer is put back on line.
<b>Notes</b>	The source routing table maintains 16 entries. After 20 seconds these entries default to the setting in this menu.  This cannot be configured from CrownAdmin 3 unless you use remote console.

### Storing Source Routing Information

The SAP (Service Access Point) route-guess table stores source routing information. It is updated using the routing information kept in one of the following:

## **Configuring Common Interface Characteristics**

- The frame last received by that SAP
- The frame last sent to a specific address and that SAP, when using a specific route found in the source routing table.

If the frame last sent or received included routing information, the guess entry is updated to try a single-route-broadcast next time. In any case, the current broadcast guess entry for an SAP is considered successful and up to date when a frame is received specifically addressed to the CrownNet interface on that SAP or a frame is sent to a specific address and that SAP.

When an entry in the SAP table is not updated, it times out after any of the following events:

- Five seconds have passed since the last transmission of a frame using a route-type-guess for the source route of that SAP.
- Three frames have been sent using a route-type-guess, after a previous route-type-guess timed out from any of the listed events.
- Ten frames have been sent using a route-type-guess after that route-type-guess was considered successful by receiving a frame addressed specifically to the CrownNet interface or by transmitting a frame along a route found in the source routing table.

When a route-type-guess entry times out, it is updated with a new guess taken in the following cycling order: no route, single route, all routes.

## Setting Ethernet Speed

The Ethernet Speed menu allows you to select the Ethernet Network Speed.

<b>Menu</b>	Administration/Communications/Resident NIC/ CrownNet/Common/Ethernet Speed Administration/Communications/Optional NIC/ CrownNet/Common/Ethernet Speed
<b>Choices</b>	Auto—Automatic selection  10Mb H/D—10 Mbit/Sec Half Duplex  100Mb H/D—100 Mbit/Sec Half Duplex
<b>Default</b>	Auto
<b>Effectivity</b>	Immediately
<b>Notes</b>	Auto is the factory default setting. A specific speed should be selected only if the Auto selection mode fails to work.  If the CrownNet software on your printer provides the Ethernet Speed option, then your start-up page shows “CrownNet 5.x FE” (Fast Ethernet).

# Configuring the EtherTalk Protocol

This section describes in detail the configuration options available in the Administration/Communications/xxxxxxx NIC/CrownNet/EtherTalk menu (where xxxxxxxx is either Resident or Optional):

- **Protocol**—Allows you to enable or disable the EtherTalk protocol.
- **Network Ident[ification]**—Allows you to specify the types of responses sent to the network.
- **Connection**—Allows you to select the appropriate type of connection between the Macintosh and the printer.
- **Zone Name**—Allows you to display and set the EtherTalk zone.

## Enabling the EtherTalk Protocol

Use the Protocol menu to enable or disable the EtherTalk protocol.

<b>Menu</b>	Administration/Communications/Resident NIC/CrownNet/EtherTalk/Protocol Administration/Communications/Optional NIC/CrownNet/EtherTalk/Protocol
<b>Choices</b>	<b>Disabled</b> —Disables access to the printer via the EtherTalk protocol. <b>Enabled</b> —Enables access to the printer via the EtherTalk protocol.
<b>Default</b>	Enabled
<b>Effectivity</b>	The CrownNet interface must be reset for changes to take effect. Use the Administration/Communications/xxxxxxx NIC/CrownNet/Common/Soft Reset menu (where xxxxxxxx is either Resident or Optional).

## **Identifying Network Settings**

Use the Network Ident menu to specify the type(s) of responses sent to the network. Three options are available:

- LaserWriter
- QMS R[emote] C[onsole] Res[ponder]
- HP Zoner Res[ponder]

### **LaserWriter**

The LaserWriter option identifies how the QMS CrownNet interface registers itself on the network for normal printing.

<b>Menu</b>	Administration/Communications/Resident NIC/CrownNet/ EtherTalk/Network Ident/LaserWriter Administration/Communications/Optional NIC/CrownNet/ EtherTalk/Network Ident/LaserWriter
<b>Choices</b>	<b>Disabled</b> —Disables the CrownNet interface from responding to network look-up requests for type “LaserWriter.” <b>Enabled</b> —Enables the CrownNet interface to respond to network look-up requests for type “LaserWriter.”
<b>Default</b>	Enabled
<b>Effectivity</b>	The CrownNet interface must be reset for changes to take effect. Use the Administration/Communications/xxxxxxx NIC/CrownNet/Common/Soft Reset menu (where xxxxxxxx is either Resident or Optional).

## **QMS RC Res (Remote Console Responder)**

The QMS RC Res option determines how the CrownNet interface registers itself for Remote Console access.

<b>Menu</b>	Administration/Communications/Resident NIC/CrownNet/ EtherTalk/Network Ident/QMS RC Res Administration/Communications/Optional NIC/CrownNet/ EtherTalk/Network Ident/QMS RC Res
<b>Choices</b>	<b>Disabled</b> —Disables the CrownNet interface from responding to network look-up requests for type “QMS_REMOTE_CONSOLE.”  <b>Enabled</b> —Enables the CrownNet interface to respond to network look-up requests for type “QMS_REMOTE_CONSOLE.” This allows Macintosh applications to determine which EtherTalk devices support QMS Remote Console functionality.
<b>Default</b>	Enabled
<b>Effectivity</b>	The CrownNet interface must be reset for changes to take effect. Use the Administration/Communications/xxxxxxx NIC/CrownNet/Common/Soft Reset menu (where xxxxxxxx is either Resident or Optional).

## **HP Zoner Res (Responder)**

The HP Zoner Res option determines how the CrownNet interface registers itself for certain EtherTalk zone-changing applications.

<b>Menu</b>	Administration/Communications/Resident NIC/CrownNet/ EtherTalk/Network Ident/HP Zoner Res Administration/Communications/Optional NIC/CrownNet/ EtherTalk/Network Ident/HP Zoner Res
<b>Choices</b>	<b>Enabled</b> —Enables the CrownNet interface to respond to network look-up requests for type “HP Zoner Responder.” This allows the Macintosh application to determine which EtherTalk devices support this zone changing functionality.  <b>Disabled</b> —Disables the CrownNet interface from responding to network look-up requests for type “HP Zoner Responder.”



## Configuring the EtherTalk Protocol

<b>Default</b>	Enabled
<b>Effectivity</b>	The CrownNet interface must be reset for changes to take effect. Use the Administration/Communications/xxxxxxx NIC/CrownNet/Common/Soft Reset menu (where xxxxxxxx is either Resident or Optional).

### Identifying the Type of Connection

The Connection menu allows you to define the appropriate type of connection between the Macintosh and the printer.

<b>Menu</b>	Administration/Communications/Resident NIC/CrownNet/ EtherTalk/Connection Administration/Communications/Optional NIC/CrownNet/ EtherTalk/Connection
-------------	--

## Configuring the EtherTalk Protocol

<p><b>Choices</b></p>	<p><b>Conventional</b>—Allows the Macintosh to print directly to the printer rather than to a print spooler. In other words, a single user can send only a single job at a time since the printer ties up the Macintosh until the job has been printed. If two users send print jobs to the printer, the Macintosh belonging to the first user is tied up until the first job has been printed, and the Macintosh belonging to the second user is tied up until both jobs have been printed. A single printer name is displayed in the Chooser (see “Notes,” below).</p> <p><b>Spooling</b>—Allows the Macintosh to send a print job to the printer even if it’s busy printing another job. In other words, the print job is spooled on the printer, and the Macintosh is free to continue working while the job is being printed. A single printer name is displayed in the Chooser (see “Notes,” below). Up to 4 print jobs can be spooling at the same time.</p> <p>» <b>Note:</b> <i>Make sure the Administration/Communications/xxxxxxx NIC/CrownNet/Common/Min K Spool menu (where xxxxxxxx is either Resident or Optional) is set large enough to support 4 jobs (approximately 800 KB).</i></p> <p><b>Both</b>—Provides both conventional and spooling capabilities. Two printer names appear in the Chooser (see “Notes,” below), and users can print to “both printers” at the same time.</p>
<p><b>Default</b></p>	<p>Conventional</p>
<p><b>Effectivity</b></p>	<p>The CrownNet interface must be reset for changes to take effect. Use the Administration/Communications/xxxxxxx NIC/CrownNet/Common/Soft Reset menu (<i>where xxxxxxxx is either Resident or Optional</i>).</p>

## Configuring the EtherTalk Protocol

<b>Notes</b>	<p><b>Conventional</b>—When Conventional is selected, if more than one printer has the same name, -1 is added to the second printer, -2 to the third printer, and so on (for example, QMS2425 and QMS2425-1).</p> <p>If you're using MultiFinder and have background printing turned on, the PrintMonitor program spools each print job on the start-up disk (Spool folder in the System Folder) before sending it to the printer. Because of this, your Macintosh is not tied up while the job is printing. See the <i>Macintosh System Software User's Guide</i> for complete information. A single printer name is displayed in the Chooser.</p> <p><b>Spooling</b>—When Spooling is selected, the printer name is displayed in the Chooser as QMS xxxx-SPOOLER, where xxxx is the printer's model number. If more than one printer has the same name, -1 is added to the second printer, -2 to the third printer, and so on (for example, QMS2425-SPOOLER and QMS2425-1-SPOOLER).</p> <p>If you're using MultiFinder, make sure background printing is turned off when using the Spooling option. Otherwise, the print job will be spooled twice, once on the Macintosh start-up disk and once on the printer, before it is printed.</p> <p><b>Both</b>—When Both is selected, both the Conventional and the Spooling printer names are displayed in the Chooser, and users can print to "both printers" at the same time.</p> <ul style="list-style-type: none"><li>» <b>Note:</b> <i>Both requires more printer memory than either Conventional or Spooling alone. If only one of these options is needed, select that one alone for better printer performance.</i></li></ul>
--------------	--

## **Setting the EtherTalk Zone**

While the preferred method of configuring the EtherTalk zone is through CrownAdmin (see “Setting the EtherTalk Zone” in chapter 3, “CrownAdmin for Macintosh”), the Zone Name menu allows you to display and set the EtherTalk zone. Three options are available:

- Zone Part 1
- Zone Part 2
- Default

### **Zone Part 1 and Zone Part 2**

Since most QMS Crown printers allow only 16 characters to display in the message window, this menu offers two name options, Zone Part 1 and Zone Part 2, allowing the zone name to be a maximum of 32 characters. Zone Part 1 records the first 16 alphanumeric characters of the zone name, and Zone Part 2 records the second 15 characters of the zone name.

<b>Menu</b>	Administration/Communications/Resident NIC/CrownNet/ EtherTalk/Zone Name/Zone Part 1, Zone Part 2 Administration/Communications/Optional NIC/CrownNet/ EtherTalk/Zone Name/Zone Part 1, Zone Part 2
<b>Choices</b>	Up to 16 alphabetic characters.
<b>Default</b>	The first zone found.
<b>Effectivity</b>	Changes take effect as soon as the printer is put back on line.
<b>Notes</b>	No entry validation is performed by the CrownNet interface. In other words, zone names are validated for legal characters, not for correct or valid EtherTalk zone names.  If you set an invalid zone name, the default zone will be used. However, the invalid zone name is stored in non-volatile memory.  Trailing spaces are not considered to be part of the zone name.

## Configuring the OS/2 LAN Manager/LAN Server or Microsoft Windows Protocol

### Default

The Default option allows you to reset the zone name (Zone Part 1 and Zone Part 2) to the default.

<b>Menu</b>	Administration/Communications/Resident NIC/CrownNet/EtherTalk/Zone Name/Default Administration/Communications/Optional NIC/CrownNet/EtherTalk/Zone Name/Default
<b>Choices</b>	<b>No</b> —Leaves the zone name as identified in the Administration/Communications/xxxxxxx NIC/CrownNet/EtherTalk/Zone Name/Zone Part 1 and Zone Part 2 menus (where xxxxxxxx is either Resident or Optional). <b>Yes</b> —Resets the zone name to the default.
<b>Default</b>	No
<b>Effectivity</b>	Changes take effect as soon as the printer is put back on line.

## Configuring the OS/2 LAN Manager/LAN Server or Microsoft Windows Protocol

This section describes in detail the configuration options available in the Administration/Communications/xxxxxxx NIC/CrownNet/Lan Manager menu (where xxxxxxxx is either Resident or Optional):

- **Protocol**—Allows you to enable or disable the NetBEUI/NetBIOS protocol.
- **Printer Name**—Provide a name for the printer on the network.
- **Default**—Allows you to reset the printer name to the default.

**Configuring the OS/2  
LAN Manager/LAN Server  
or Microsoft Windows  
Protocol**

**Enabling the OS/2 LAN Manager/LAN Server  
or Microsoft Windows Network Protocol**

The Protocol menu allows you to enable or disable the OS/2 LAN Manager/LAN Server or Microsoft Windows Network protocol.

<b>Menu</b>	Administration/Communications/Resident NIC/CrownNet/Lan Manager/Protocol Administration/Communications/Optional NIC/CrownNet/Lan Manager/Protocol
<b>Choices</b>	<b>Enabled</b> —Enables the NetBEUI/NetBIOS protocol. <b>Disabled</b> —Disables the NetBEUI/NetBIOS protocol.
<b>Default</b>	Enabled
<b>Effectivity</b>	The CrownNet interface must be reset for changes to take effect. Use the Administration/Communications/xxxxxxx NIC/CrownNet/Common/Soft Reset menu (where xxxxxxxx is either Resident or Optional), or restart the printer.

**Naming the Printer**

One unique printer name is broadcast to the network for printer identification. However, multiple connections to this one printer are possible. The Printer Name menu allows you to provide a printer name up to 16 characters long.

<b>Menu</b>	Administration/Communications/Resident NIC/CrownNet/Lan Manager/Printer Name Administration/Communications/Optional NIC/CrownNet/Lan Manager/Printer Name
<b>Choices</b>	See the "Guidelines" below
<b>Default</b>	QMS_ <i>hwaddress</i> where <i>hwaddress</i> is the hardware address set in the Administration/Communications/xxxxxxx NIC/CrownNet/Common/HW Address menu (where xxxxxxxx is either Resident or Optional).
<b>Effectivity</b>	The CrownNet interface must be reset for changes to take effect. Use the Administration/Communications/xxxxxxx NIC/CrownNet/Common/Soft Reset menu (where xxxxxxxx is either Resident or Optional), or you must restart the printer.
<b>Notes</b>	No two printers on a network may have the same printer name.

## **Guidelines**

Keep the following in mind when naming the printer:

- Printer names may be up to 16 characters long.
- Only uppercase characters are allowed.
- Spaces are not allowed in printer names. The first space found ends the name even if you enter other characters to the right of the space. These subsequent characters are cleared to spaces.
- You can use an underscore character ( \_ ) to create a name consisting of more than one word. For example, you may want to name the printer

PROGRAM\_MGT

## **Resetting the Printer Name**

The Default menu allows you to reset the printer name to the default.

<b>Menu</b>	Administration/Communications/Resident NIC/CrownNet/Lan Manager/Default Administration/Communications/Optional NIC/CrownNet/Lan Manager/Default
<b>Choices</b>	<b>No</b> —Leaves the printer name as identified in the Administration/Communications/xxxxxxx NIC/CrownNet/Lan Manager/Printer Name menu (where xxxxxxxx is either Resident or Optional). <b>Yes</b> —Resets the printer name to the default.
<b>Default</b>	No
<b>Effectivity</b>	Changes take effect as soon as the printer is put back on line.
<b>Notes</b>	No two printers on a network may have the same printer name.

# Configuring the NetWare Protocol

This section explains how the CrownNet interface provides security in the NetWare environment, and it describes in detail each of the configuration options available in the Administration/Communications/xxxxxxx NIC/CrownNet/NetWare menu (where xxxxxxxx is either Resident or Optional):

- **Protocol**—Allows you to enable and disable the NetWare protocol.
  - **Config PServer**—Allows you to provide information about the printer's internal print server and configure the print server in bindery mode or NDS mode.
  - **R/N Printer #1-R/N Printer #8**—Allows you to supply the network with information about the remote/network printer
  - **Printer Name**—Allows you to specify the name by which the printer is known on the network.
  - **Frame Type**—Allows you to specify the frame type used by the NetWare interface.
- » **Note:** *The preferred method of configuring the NetWare interface is through CrownAdmin 3 for Windows utility.*

## About the CrownNet Security Feature

Through the implementation of a print server password, the CrownNet print server prevents unauthorized access to private print queues.

The first time the CrownNet print server attaches to a file server, the CrownNet interface automatically creates a hidden password for the CrownNet print server and stores it in encrypted form on the file server. Each subsequent time the CrownNet print server attaches to the file server, the hidden, encrypted password is used.



Because it is based on the unique, network address of the CrownNet interface, this password prevents unauthorized printers from accessing private print queues by using the name of a print server authorized to access those queues. Only one CrownNet interface will generate the correct password associated with a specific print server name.

### Reassigning a Password

Once a CrownNet print server name has been assigned to a printer, if the print server name is reassigned to a different printer, the print server password must be reset to allow the new printer to connect to the file server.

Use the following procedure to reassign a password.

- » **Note:** *This procedure must be repeated on each file server that has been serviced by the CrownNet print server.*

- 1 Open PConsole.**
- 2 From the Available Options list select Print Server Information.**
- 3 From the Print Servers list select the print server.**
- 4 From the Print Server Information list select Password.**
- 5 Make sure the cursor is in the leftmost position and press Enter to set the new password.**
- 6 Make sure the cursor remains in the leftmost position and press Enter again to verify the new password.**
- 7 Exit from PConsole.**

The password has been reset, and the print server name may be used by another printer.

- » **Note:** *You can also clear the password through CrownAdmin 3.*

### Enabling the NetWare Protocol

The Protocol menu allows you to enable or disable the NetWare protocol.

<b>Menu</b>	Administration/Communications/Resident NIC/CrownNet/NetWare/Protocol Administration/Communications/Optional NIC/CrownNet/NetWare/Protocol
<b>Choices</b>	<b>Enabled</b> —Enables the NetWare protocol. <b>Disabled</b> —Disables the NetWare protocol.
<b>Default</b>	Enabled
<b>Effectivity</b>	The CrownNet interface must be reset for changes to take effect. Use the Administration/Communications/xxxxxxx NIC/CrownNet/Common/Soft Reset menu (where xxxxxxxx is either Resident or Optional).

### Configuring the Print Server

The Config PServer menu provides information about the printer's internal print server. The printer's internal print server can be configured as a NetWare 3.x bindery print server and as a NetWare 4.x NDS print server.

- » **Note:** *This print server services its own attached printer. It does not support other remote printers on the network. The eight configurable remote printers must be serviced by additional print servers located elsewhere on the network.*

The following options are available:

- File Srv Name[1]
- File Srv Name[2]
- File Srv Name[3]
- Default
- PServer Name[1]
- PServer Name[2]

- PServer Name[3]
- Job Check Delay
- Conf Check Delay
- Burst Mode
- PServer Context[1]
- PServer Context[2]
- PServer Context[3]

To set up the print server in NetWare 3.x bindery mode, configure these menu options:

- File Svr Name
- PServer Name

To set up the print server in NetWare 4.x NDS mode, configure this menu option:

- PServer Context

You may configure these menu options in either mode:

- Job Check Delay
- Conf Check Delay
- Burst Mode

## **Naming the Bindery File Server**

The File Srv Name[1], File Srv Name[2], and File Srv Name[3] options allow you to identify the name of the configuration bindery file server.

- » **Note:** *The three File Srv Name options allow you to set only a single file server name. However, this name can be up to 47 characters in length. See the “Guidelines,” below.*

<b>Menu</b>	Administration/Communications/Resident NIC/CrownNet/ NetWare/Config PServer/File Srv Name[1], File Srv Name[2], File Srv Name[3] Administration/Communications/Optional NIC/CrownNet/ NetWare/Config PServer/File Srv Name[1], File Srv Name[2], File Srv Name[3]
<b>Choices</b>	Up to 47 characters (see “Guidelines,” below)
<b>Default</b>	[Blank]
<b>Effectivity</b>	The CrownNet interface must be reset for changes to take effect. Use the Administration/Communications/xxxxxxx NIC/ CrownNet/Common/Soft Reset menu (where xxxxxxxx is either Resident or Optional).
<b>Notes</b>	Use the Administration/Communications/xxxxxxx NIC/ CrownNet/NetWare/Config PServer/Default menu (where xxxxxxxx is either Resident or Optional) to reset the file server name to the default.  For more than one bindery file server, use CrownAdmin 3.

### **Guidelines**

Keep the following in mind when naming the file server:

- File server names may be up to 47 characters long in NetWare versions 3.x. Only 47 characters can be entered through the printer configuration menu. If the file server name has more than 16 characters, enter the first 16 characters in the File Srv Name[1] menu and then up to 16 additional characters in the File Srv Name[2] menu. If a file server name has more than 32

characters, enter up to 15 additional characters in the File Srv Name[3] menu.

- Only uppercase characters are allowed.
- Spaces are not allowed in file server names. The first space found ends the name even if you enter other characters to the right of the space. These subsequent characters are cleared to spaces.
- You can use an underscore character ( \_ ) to create a name consisting of more than one word. For example, to create a file server called Marketing\_Server, you would display

MARKETING\_SERVER

### Resetting the File Server Name

The Default menu allows you to reset the file server name to the default.

<b>Menu</b>	Administration/Communications/Resident NIC/CrownNet/NetWare/Config PServer/Default Administration/Communications/Optional NIC/CrownNet/NetWare/Config PServer/Default
<b>Choices</b>	<b>No</b> —Leaves the file server name as identified in the Administration/Communications/xxxxxxx NIC/CrownNet/NetWare/Config PServer/File Srv Name 1, File Srv Name 2, and File Srv Name 3 menus (where xxxxxxxx is either Resident or Optional). <b>Yes</b> —Resets the file server name to the default.
<b>Default</b>	No
<b>Effectivity</b>	The CrownNet interface must be reset for changes to take effect. Use the Administration/Communications/xxxxxxx NIC/CrownNet/Common/Soft Reset menu (where xxxxxxxx is either Resident or Optional).

## **Naming the Bindery Print Server**

The PServer Name[1], PServer Name[2], and PServer Name[3] options allow you to identify the name of the CrownNet internal print server.

<b>Menu</b>	Administration/Communications/Resident NIC/CrownNet/NetWare/Config PServer/PServer Name[1], PServer Name[2], PServer Name[3] Administration/Communications/Optional NIC/CrownNet/NetWare/Config PServer/PServer Name[1], PServer Name[2], PServer Name[3]
<b>Choices</b>	Up to 47 characters (see "Guidelines," below)
<b>Default</b>	[Blank]
<b>Effectivity</b>	The CrownNet interface must be reset for changes to take effect. Use the Administration/Communications/xxxxxxx NIC/CrownNet/Common/Soft Reset menu (where xxxxxxx is either Resident or Optional).

### **Guidelines**

Keep the following in mind when naming the bindery print server:

- Print server names may be up to 47 characters long using Netware 3.x. If the print server name has more than 16 characters, enter the first 16 characters in the PServer Name[1] menu and then up to 16 additional characters in the PServer Name[2] menu. If a server name has more than 32 characters, enter up to 15 additional characters in the PServer Name[3] menu.
- Only uppercase characters are allowed.
- Spaces are not allowed in print server names. The first space found ends the name even if you enter other characters to the right of the space. These subsequent characters are cleared to spaces.
- You can use an underscore character ( \_ ) to create a name consisting of more than one word. For example, you could name the print server as

QMS\_PSERVER\_MARKETNGPSER

## **Setting the Job Check Delay**

The Job Check Delay option allows you to select the number of seconds between times that the print server checks each print queue for print jobs. This can be used to limit network traffic. Keep in mind the longer the delay the longer the time that a queued job is released for printing and the time that a Print Server begins to print the job.

<b>Menu</b>	Administration/Communications/Resident NIC/CrownNet/ NetWare/Config PServer/Job Check Delay Administration/Communications/Optional NIC/CrownNet/ NetWare/Config PServer/Job Check Delay
<b>Choices</b>	1-60 seconds
<b>Default</b>	15 seconds
<b>Effectivity</b>	Changes in this menu take effect as soon as the printer is put back on line.

## **Configuring Check Delay**

The Conf Check Delay option allows you to configure the time interval that the print server on the CrownNet interface will broadcast to check its connection. This broadcast checks the network configuration to see if any changes have been made.

<b>Menu</b>	Administration/Communications/Resident NIC/CrownNet/ NetWare/Config PServer/Conf Check Delay Administration/Communications/Optional NIC/CrownNet/ NetWare/Config PServer/Conf Check Delay
<b>Choices</b>	0-65535 seconds
<b>Default</b>	300 seconds
<b>Effectivity</b>	Changes in this menu take effect as soon as the printer is put back on line.
<b>Notes</b>	0 = disabled

## Setting Burst Mode

Setting burst mode allows you to enable or disable NCP burst mode, which allows very high speed data transfer in NetWare networks.

<b>Menu</b>	Administration/Communications/Resident NIC/CrownNet/NetWare/Config PServer/Burst Mode Administration/Communications/Optional NIC/CrownNet/NetWare/Config PServer/Burst Mode
<b>Choices</b>	Enabled/Disabled
<b>Default</b>	Enabled
<b>Effectivity</b>	Changes in this menu take effect as soon as the printer is put back on line.

## Naming the NDS Print Server

The PServer Context[1], PServerPServer Context[2], and PServer Context[3] options allow you to identify the name of the NDS configuration file server and the print server context. the format for the option is file server name first, followed by a a space, and then the print server context. For example, if the configuration file server name is QMS-4 and the print server context is printserv2.sales.qms, the entry would be

QMS-4 PRINTSERV2 . SALES . QMS

Up to 16 characters can be entered in the PServer Context[1] field, and additional 16 characters in PServer Context[2], and an additional 15 characters in PServer Context[3]

- » **Note:** *If you want to assign more than 14 characters to the file server name you must use CrownAdmin 3 to enter the name.*

<b>Menu</b>	Administration/Communications/Resident NIC/CrownNet/NetWare/Config PServer/PServer Context[X] Administration/Communications/Optional NIC/CrownNet/NetWare/Config PServer/PServer Context[X]
<b>Choices</b>	Up to 47 characters (see "Guidelines," below)
<b>Default</b>	[Blank]



<b>Effectivity</b>	The CrownNet interface must be reset for changes to take effect. Use the Administration/Communications/xxxxxxx NIC/CrownNet/Common/Soft Reset menu (where xxxxxxxx is either Resident or Optional).
<b>Notes</b>	The file server name must be contained within the first 16 characters. If the name you are entering is longer than 14 characters you must use the CrownAdmin 3 Edit Settings menu to enter the name.

### Guidelines

Keep the following in mind when naming PServer Context:

- In NetWare version 4.x, names may be as long as 256 characters. Only 47 characters can be entered through the printer configuration menu. If you want to enter names greater than 47 characters you must use host-based configurations, such as CrownAdmin 3. If the PServer Context name has more than 16 characters, enter the first 16 characters in the PServer Context[1] menu and then up to 16 additional characters in the PServer Context[2] menu. If a PServer Context name has more than 32 characters, enter up to 15 additional characters in the PServer Context[3] menu.
- Only uppercase characters are allowed.
- A space is used to separate the name of the file server from the print server context.
- You can use a period (.) to create a name consisting of more than one word. The period could be used to separate the levels of context. For example, to identify a print server named PRINTSERV2.SALES.QMS, you would display

QMS-4 PRINTSERV2.SALES.QMS

- » **Note:** *If you want to assign more than 14 characters to the file server name you must use CrownAdmin 3 to enter the name.*

## **Configuring the Remote/Network Printers**

The R/N Printer menus allow you to configure the remote/network printers. Since the CrownNet interface supports up to eight remote/network printers, eight menus are available—R/N Printer 1 through R/N Printer 8. Each menu has identical configuration options:

- Printer Slot #
- PServer Name[1]
- PServer Name[2]
- PServer Name[3]
- Default

### **Identifying the Slot Number**

The Printer Slot # option allows you to identify the printer slot number. This number must match the slot number chosen in PConsole's Print Server Configuration/Printer Configuration menu.

<b>Menu</b>	Administration/Communications/Resident NIC/CrownNet/ NetWare/R/N Printer/Printer Slot # Administration/Communications/Optional NIC/CrownNet/ NetWare/R/N Printer/Printer Slot #
<b>Choices</b>	000-254
<b>Defaults</b>	R/N Printer 1—001 R/N Printer 2—002 R/N Printer 3—003 R/N Printer 4—004 R/N Printer 5—005 R/N Printer 6—006 R/N Printer 7—007 R/N Printer 8—008
<b>Effectivity</b>	The CrownNet interface must be reset for changes to take effect. Use the Administration/Communications/xxxxxxx NIC/ CrownNet/Common/Soft Reset menu (where xxxxxxxx is either Resident or Optional).

## **Naming the Print Server**

The PServer Name[1], PServer Name[2], and PServer Name[3] options allow you to identify the name of the print server serving the remote printer.

- » **Note:** *The print server identified in this menu may not be CrownNet's internal print server (Administration/Communications/CrownNet/NetWare/Config PServer/PServer Name [1], PServer Name[2], and PServer Name [3] menus.*

<b>Menu</b>	Administration/Communications/Resident NIC/CrownNet/NetWare/RN Printer/PServer Name[1], PServer Name[2], PServer Name[3] Administration/Communications/Optional NIC/CrownNet/NetWare/RN Printer/PServer Name[1], PServer Name[2], PServer Name[3]
<b>Choices</b>	Up to 47 characters (see "Guidelines," below)
<b>Default</b>	<blank>
<b>Effectivity</b>	The CrownNet interface must be reset for changes to take effect. Use the Administration/Communications/xxxxxxx NIC/CrownNet/Common/Soft Reset menu (where xxxxxxxx is either Resident or Optional).

### **Guidelines**

Keep the following in mind when naming the print server:

- Print server names may be up to 47 characters long in NetWare versions 3.x. In Netware version 4.x name and context may be as long as 256 characters. Only 47 characters can be entered through the printer configuration menu. If you wish to enter names greater than 47 characters you must use host based configurations such as CrownAdmin 3. For NetWare versions 3.x, if the print server name has more than 16 characters, enter the first 16 characters in the PServer Name[1] menu and then up to 16 additional characters in the PServer Name[2] menu. If a file server name has more than 32 characters, enter up to 15 additional characters in the PServer Name[3] menu.

## Configuring the NetWare Protocol

- Only uppercase characters are allowed.
- Spaces are not allowed in print server names. The first space found ends the name even if you enter other characters to the right of the space. These subsequent characters are cleared to spaces.
- You can use an underscore character ( \_ ) to create a name consisting of more than one word. For example, to identify a print server named `MARKETING_SERVER`, you would display

`MARKETING_PSERVER`

## Resetting the Print Server Name

The Default menu allows you to reset the print server name to the default.

<b>Menu</b>	Administration/Communications/Resident NIC/CrownNet/NetWare/R/N Printer x/Default Administration/Communications/Optional NIC/CrownNet/NetWare/R/N Printer x/Default
<b>Choices</b>	No—Leaves the print server name as identified in the Administration/Communications/xxxxxxx NIC/CrownNet/NetWare/R/N Printer x/PServer Name[1], PServer Name[2], and PServer Name [3] menus (where xxxxxxxx is either Resident or Optional). Yes—Clears the print server name.
<b>Default</b>	None
<b>Effectivity</b>	The CrownNet interface must be reset for changes to take effect. Use the Administration/Communications/xxxxxxx NIC/CrownNet/Common/Soft Reset menu (where xxxxxxxx is either Resident or Optional).

## **Specifying a Printer Name**

The Printer Name menu allows you to specify a name by which the printer is known on the network. Four options are available:

- Printer Name 1
- Printer Name 2
- Printer Name 3
- Default

» **Note:** *This name will only make the printer name known to CrownAdmin 3 network utility.*

### **Specifying Printer Name 1, Printer Name 2, and Printer Name 3**

The Printer Name 1, Printer Name 2, and Printer Name 3 options allow you to specify a name of the printer known to CrownAdmin 3.

» **Note:** *The three Name options allow you to set only a single printer name up to 47 characters in length. See the "Guidelines," below.*

<b>Menu</b>	Administration/Communications/Resident NIC/CrownNet/ NetWare/Printer Name/Name 1, Name 2, Name 3 Administration/Communications/Optional NIC/CrownNet/ NetWare/Printer Name/Name 1, Name 2, Name 3
<b>Choices</b>	Up to 47 characters (see "Guidelines," below)
<b>Default</b>	QMS_xxxx_Print_System_hardwareaddress, where xxxx is the printer model number and hardwareaddress is the printer's hardware address as found on the printer start-up page.
<b>Effectivity</b>	When the printer is placed back online.
<b>Notes</b>	Use the Administration/Communications/xxxxxxx NIC/ CrownNet/NetWare/Printer Name/Default menu (where xxxxxxx is either Resident or Optional) to reset the printer name to the default.  No two printers on the network may have the same name.

## Configuring the NetWare Protocol

### Guidelines

Keep the following in mind when naming the printer:

- Printer names may be up to 47 characters long. If the printer name has more than 16 characters, enter the first 16 characters in the Name[1] menu and then up to 16 additional characters in the Name[2] menu. If a print server name has more than 32 characters, enter up to 15 additional characters in the Name[3] menu.
- Only uppercase characters are allowed.
- Spaces are not allowed in printer names. The first space found ends the name even if you enter other characters to the right of the space. These subsequent characters are cleared to spaces.
- You can use an underscore character ( \_ ) to create a name consisting of more than one word. For example, you may want to name the printer

PROGRAM\_MGT

### Default

The Default option allows you to reset the printer name to the default.

<b>Menu</b>	Administration/Communications/Resident NIC/CrownNet/NetWare/Printer Name/Default Administration/Communications/Optional NIC/CrownNet/NetWare/Printer Name/Default
<b>Choices</b>	<b>No</b> —Leaves the printer name as identified in the Administration/Communications/xxxxxxx NIC/CrownNet/NetWare/Printer Name/Name 1, Name 2, and Name 3 menus (where xxxxxxxx is either Resident or Optional). <b>Yes</b> —Sets the name back to the QMS default printer name.
<b>Default</b>	<blank>
<b>Effectivity</b>	Changes take effect as soon as the printer is put back on line.
<b>Notes</b>	No two printers on a network may have the same name.

## Setting the Frame Type

The printer automatically detects the frame types used on the network. However, if you don't want the printer to see all of them, you can disable one or more in the appropriate menu:

- 802.3 IPX Addr[ess]
- Ether2 IPX Addr[ess]
- 802.2 IPX Addr[ess]
- SNAP IPX Addr[ess]
- 802.5 IPX Addr[ess]

### 802.3 IPX Addr for Ethernet

<b>Menu</b>	Administration/Communications/Resident NIC/CrownNet/NetWare/Frame Types/802.3 IPX Addr Administration/Communications/Optional NIC/CrownNet/NetWare/Frame Types/802.3 IPX Addr
<b>Choices</b>	<b>Enabled</b> —Enables the frame type. <b>Disabled</b> —Disables the frame type.
<b>Default</b>	Enabled
<b>Effectivity</b>	The CrownNet interface must be reset for changes to take effect. Use the Administration/Communications/xxxxxxx NIC/CrownNet/Common/Soft Reset menu (where xxxxxxx is either Resident or Optional).

### Ether2 IPX Addr for Ethernet

<b>Menu</b>	Administration/Communications/Resident NIC/CrownNet/NetWare/Frame Type/ Ether2 IPX Addr Administration/Communications/Optional NIC/CrownNet/NetWare/Frame Type/ Ether2 IPX Addr
<b>Choices</b>	<b>Enabled</b> —Enables the frame type. <b>Disabled</b> —Disables the frame type.
<b>Default</b>	Enabled

## Configuring the NetWare Protocol

<b>Effectivity</b>	The CrownNet interface must be reset for changes to take effect. Use the Administration/Communications/xxxxxxx NIC/CrownNet/Common/Soft Reset menu (where xxxxxxxx is either Resident or Optional).
--------------------	---

### 802.2 IPX Addr for Ethernet

<b>Menu</b>	Administration/Communications/Resident NIC/CrownNet/NetWare/Frame Type/802.2 IPX Addr Administration/Communications/Optional NIC/CrownNet/NetWare/Frame Type/802.2 IPX Addr
<b>Choices</b>	<b>Enabled</b> —Enables the frame type. <b>Disabled</b> —Disables the frame type.
<b>Default</b>	Enabled
<b>Effectivity</b>	The CrownNet interface must be reset for changes to take effect. Use the Administration/Communications/xxxxxxx NIC/CrownNet/Common/Soft Reset menu (where xxxxxxxx is either Resident or Optional).

### SNAP IPX Addr for Ethernet or Token-Ring

<b>Menu</b>	Administration/Communications/Resident NIC/CrownNet/NetWare/Frame Type/ SNAP IPX Addr Administration/Communications/Optional NIC/CrownNet/NetWare/Frame Type/ SNAP IPX Addr
<b>Choices</b>	<b>Enabled</b> —Enables the frame type. <b>Disabled</b> —Disables the frame type.
<b>Default</b>	Enabled
<b>Effectivity</b>	The CrownNet interface must be reset for changes to take effect. Use the Administration/Communications/xxxxxxx NIC/CrownNet/Common/Soft Reset menu (where xxxxxxxx is either Resident or Optional).



## **802.5 IPX Addr for Token-Ring**

<b>Menu</b>	Administration/Communications/Resident NIC/CrownNet/ NetWare/Frame Type/802.5 IPX Addr Administration/Communications/Optional NIC/CrownNet/ NetWare/Frame Type/802.5 IPX Addr
<b>Choices</b>	<b>Enabled</b> —Enables the frame type. <b>Disabled</b> —Disables the frame type.
<b>Default</b>	Enabled
<b>Effectivity</b>	The CrownNet interface must be reset for changes to take effect. Use the Administration/Communications/xxxxxxx NIC/ CrownNet/Common/Soft Reset menu (where xxxxxxx is either Resident or Optional).

# **Configuring the TCP/IP Protocol**

This section describes in detail the configuration options available in the Administration/Communications/xxxxxxx NIC/CrownNet/TCP/IP menu (where xxxxxxx is either Resident or Optional):

- **Protocol**—Allows you to enable and disable the TCP/IP protocol.
- **Internet Address**—Allows you to assign a network address to the printer.
- **Subnet Mask**—Allows you to set the subnet mask.
- **Default Router**—Allows you to specify the Internet address for the default router.
- **Remove Passwords**—Allows you to delete the FTP password file on the printer.
- **Remove Hosts**—Allows you to delete the host file on the printer.
- **Secure Files**—Allows you to lock the password and host files on the printer.

## Configuring the TCP/IP Protocol

- **Accnting/Revchan**—Allows you to enable TCP/IP accounting and reverse channel (backchannel) information.
- **Accnting Timeout**—Allows you to set the amount of time the CrownNet interface waits for a terminating acknowledgment from the host before allowing another connection.
- **Port Assignment**—Allows you to set the port that is used for TRANSPORT1/STATUS1 communications.
- **LPD Banner**—Allows you to print a banner page after an LPD print job.
- **BOOTP**—Allows you to disable bootp protocol.
- **RARP**—Allows you to disable rarp protocol.
- **SNMP NMS 1-SNMP NMS 5**—Allows you to configure SNMP (Simple Network Management Protocol), a protocol used to monitor devices, the networks to which they attach, and the network management stations (NMSs) to which SNMP data is reported.

## Enabling the TCP/IP Protocol

The Protocol menu allows you to enable or disable the TCP/IP protocol.

<b>Menu</b>	Administration/Communications/Resident NIC/CrownNet/TCPIP/Protocol Administration/Communications/Optional NIC/CrownNet/TCPIP/Protocol
<b>Choices</b>	<b>Enabled</b> —Enables the TCP/IP protocol. <b>Disabled</b> —Disables the TCP/IP protocol.
<b>Default</b>	Enabled
<b>Effectivity</b>	The CrownNet interface must be reset for changes to take effect. Use the Administration/Communications/xxxxxxx NIC/CrownNet/Common/Soft Reset menu (where xxxxxxxx is either Resident or Optional).

## **Setting the Internet Address**

The Internet Address menu allows you to set the printer's network (Internet) address. The address is in the format *xxx.xxx.xxx.xxx*. The address must be set and must be unique.

<b>Menu</b>	Administration/Communications/Resident NIC/CrownNet/ TCPIP/Internet Address Administration/Communications/Optional NIC/CrownNet/ TCPIP/Internet Address
<b>Choices</b>	Each <i>xxx</i> triplet can have a value of 001-255.
<b>Default</b>	161.033.128.024
<b>Effectivity</b>	The CrownNet interface must be reset for changes to take effect. Use the Administration/Communications/ <i>xxxxxxx</i> NIC/CrownNet/Common/Soft Reset menu (where <i>xxxxxxx</i> is either Resident or Optional).

## **Guidelines**

Keep the following guidelines in mind when setting the Internet address:

- The address must consist only of numbers and periods. Selecting a letter or another symbol results in an error message.
- Any *xxx* value between 10 and 99 must begin with 0 (for example, 10 is entered as 010 and 99 is entered as 099).
- Any *xxx* value between 1 and 9 must begin with 00 (for example, 1 is entered as 001 and 9 is entered as 009).

## **Setting the Subnet Mask**

The Subnet Mask menu allows you to set the printer's subnet mask. The mask has the form 000.000.000.000. Each triplet is a number from 001 to 255. If subnets are not used with your network, the subnet address should be 000.000.000.000. Check with your network administrator. See appendix C, "SNMP and TCP/IP Concepts," for more information on subnetting and subnet masks.

<b>Menu</b>	Administration/Communications/Resident NIC/CrownNet/TCP/IP/Subnet Mask Administration/Communications/Optional NIC/CrownNet/TCP/IP/Subnet Mask
<b>Choices</b>	Each xxx triplet can have a value from 001 to 255.
<b>Default</b>	000.000.000.000
<b>Effectivity</b>	The CrownNet interface must be reset for changes to take effect. Use the Administration/Communications/xxxxxxx NIC/CrownNet/Common/Soft Reset menu (where xxxxxxxx is either Resident or Optional).
<b>Notes</b>	If the subnet mask remains set to the default (000.000.000.000), the CrownNet interface provides automatic sensing of gateways. If you identify a subnet mask, this automatic sensing is disabled.

## **Guidelines**

Keep the following guidelines in mind when setting the subnet mask:

- The address must consist only of numbers and periods. Selecting a letter or another symbol results in an error message.
- Any xxx value between 10 and 99 must begin with 0 (for example, 10 is entered as 010 and 99 is entered as 099).
- Any xxx value between 1 and 9 must begin with 00 (for example, 1 is entered as 001 and 9 is entered as 009).

## **Setting the Default Router Address**

The Default Router menu allows you to set the Internet address of the default router. The address has the form 000.000.000.000. Each triplet is a number from 001 to 255. If gateways are not used with your network, the gateway address should be 000.000.000.000 (the factory default). Check with your network administrator. See appendix C, “SNMP and TCP/IP Concepts,” for more information on gateways and internet routing.

<b>Menu</b>	Administration/Communications/Resident NIC/CrownNet/ TCPIP/Default Router Administration/Communications/Optional NIC/CrownNet/ TCPIP/Default Router
<b>Choices</b>	Each xxx triplet can have a value from 001 to 255.
<b>Default</b>	000.000.000.000
<b>Effectivity</b>	The CrownNet interface must be reset for changes to take effect. Use the Administration/Communications/xxxxxxx NIC/ CrownNet/Common/Soft Reset menu (where xxxxxxxx is either Resident or Optional).

### **Guidelines**

Keep the following guidelines in mind when setting the Internet address:

- The address must consist only of numbers and periods. Selecting a letter or another symbol results in an error message.
- Any xxx value between 10 and 99 must begin with 0 (for example, 10 is entered as 010 and 99 is entered as 099).
- Any xxx value between 1 and 9 must begin with 00 (for example, 1 is entered as 001 and 9 is entered as 009).

## **Deleting the FTP Password File**

The Remove Passwords menu allows you to delete the FTP password file PASSWD.FTP. This removes the need for password validation of users for FTP and Telnet. See Chapter 7, “UNIX Utilities” for more information on password files.

<b>Menu</b>	Administration/Communications/Resident NIC/CrownNet/ TCPIP/Remove Passwords Administration/Communications/Optional NIC/CrownNet/ TCPIP/Remove Passwords
<b>Choices</b>	<b>Yes</b> —Delete the FTP password files. <b>No</b> —Do not remove the FTP password files.
<b>Default</b>	No
<b>Effectivity</b>	Changes to this menu take effect immediately.

## **Deleting the Host Files**

The Remove Hosts menu allows you to delete the HOST.EQ host address file. This eliminates host protection. See Chapter 7, “UNIX Utilities” for more information on the host file.

<b>Menu</b>	Administration/Communications/Resident NIC/CrownNet/ TCPIP/Remove Hosts Administration/Communications/Optional NIC/CrownNet/ TCPIP/Remove Hosts
<b>Choices</b>	<b>Yes</b> —Remove the host files. <b>No</b> —Do not remove the host files.
<b>Default</b>	No
<b>Effectivity</b>	Changes to this menu take effect immediately.

## **Blocking Access to Printer Files**

The Secure Files menu allows you to block network access to files on the printer's hard disk by locking the password and host files on the printer. This option overrides the Administration menu password.

<b>Menu</b>	Administration/Communications/Resident NIC/CrownNet/ TCPIP/Secure Files Administration/Communications/Optional NIC/CrownNet/ TCPIP/Secure Files
<b>Choices</b>	<b>Yes</b> —Does not allow users with “root” privileges to <b>put</b> or <b>get</b> files from anywhere except /usr/files. (See your printer documentation for the full pathname.) <b>No</b> —Allows users with “root” privileges to <b>get</b> or <b>put</b> files from any location on the printer's disk.
<b>Default</b>	No
<b>Effectivity</b>	Changes to this menu take effect immediately.
<b>Notes</b>	If this menu is set to Yes and a user with “root” privileges tries to <b>get</b> or <b>put</b> a file, the following error message displays:  FILES SECURED, PLEASE UN-SECURE AND TRY AGAIN  You must set this menu to No before you can <b>get</b> or <b>put</b> a file.

## **Enabling TCP/IP Accounting and Reverse Channel Communications**

The Accnting/Revchan [Accounting/Reverse Channel] menu allows you to obtain print job status information, including the following: status of the current job (waiting, terminating, printing, rasterizing, interpreting, or spooling), current interface, number of sheets of media, job id, user name, and filename. (See appendix C, “SNMP and TCP/IP Concepts,” for more information on the accounting and back channel features.)

- » **Note:** *TCP/IP accounting/reverse channel is available only on some printers. The CrownNet interface determines if the motherboard supports this feature.*

## Configuring the TCP/IP Protocol

<b>Menu</b>	Administration/Communications/Resident NIC/CrownNet/ TCPIP/AcctingRevChan Administration/Communications/Optional NIC/CrownNet/ TCPIP/AcctingRevChan
<b>Choices</b>	<b>Enabled</b> —Enables TCP/IP accounting and reverse channel communications and sends accounting information back to the host via UDP packets.  <b>Disabled</b> —Disables TCP/IP accounting and reverse channel communications.
<b>Default</b>	Disabled
<b>Effectivity</b>	Changes to this menu take effect as soon as you put the printer back on line.
<b>Notes</b>	Because the accounting feature relays the number of pages printed for each print job, using On Idle spooling [Administration/Communications/xxxxxxx NIC/CrownNet/Common/Spooling menu (where xxxxxxxx is either Resident or Optional)] to define discrete job boundaries is required to ensure that all pages in a job have been counted before the next job begins printing. Therefore, selecting Enabled enables accounting and automatically sets Spooling to On Idle. Conversely, if Spooling is set to On or On Input Idle, the Accting/RevChan menu is automatically set to Disabled.

## Setting an Accounting Timeout

The Accting Timeout menu allows you to set the number of seconds the CrownNet interface waits for a terminating acknowledgment from the host before allowing another connection.

<b>Menu</b>	Administration/Communications/Resident NIC/CrownNet/ TCPIP/Accting Timeout Administration/Communications/Optional NIC/CrownNet/ TCPIP/Accting Timeout
<b>Choices</b>	005-600 sec. (5 sec.-10 min.)
<b>Default</b>	15 sec.
<b>Effectivity</b>	Changes to this menu take effect as soon as you put the printer back on line.



## **Assigning a TCP/IP Port**

Some application environments have identical port assignments to the QMS TCP/IP interface. The Port Assignment menu allows you to assign a port number to the QMS TCP/IP interface to provide compatibility with these other environments.

<b>Menu</b>	Administration/Communications/Resident NIC/CrownNet/ TCPIP/Port Assignment Administration/Communications/Optional NIC/CrownNet/ TCPIP/Port Assignment
<b>Choices</b>	1-9999
<b>Default</b>	35
<b>Effectivity</b>	The CrownNet interface must be reset for changes to take effect. Use the Administration/Communications/xxxxxxx NIC/CrownNet/Common/Soft Reset menu (where xxxxxxxx is either Resident or Optional).
<b>Notes</b>	This value must be unique and must not be used by any other services, such as ftp, telnet, and rlogin.  The QMS UNIX Host Software must be configured to the same port number.

Once entered, the requested port number assignment is checked against those currently assigned. If the requested port number coincides with a port number already in use by the TCP/IP interface, the error message `INCORRECT VALUE` is displayed in the printer control panel message window or on the remote console.

- » **Note:** *If you change the port number in the Port Assignment menu, you must also change the port number used in the UNIX Host Software.*

## **Printing an LPD Banner Page**

This menu allows you to print a banner page after an LPD print job.

<b>Menu</b>	Administration/Communications/Resident NIC/CrownNet/ TCPIP/LPD Banner Administration/Communications/Optional NIC/CrownNet/ TCPIP/LPD Banner
<b>Choices</b>	<b>Enabled</b> —Print a banner page after the job. <b>Disabled</b> —Do not print the banner page.
<b>Default</b>	Enabled
<b>Effectivity</b>	Changes to this menu take effect immediately.

## **Disabling the BOOTP Protocol**

The BOOTP menu allows you to enable or disable the BOOTP protocol.

<b>Menu</b>	Administration/Communications/Resident NIC/CrownNet/ TCPIP/Protocol/BOOTP Administration/Communications/Optional NIC/CrownNet/ TCPIP/Protocol/BOOTP
<b>Choices</b>	<b>Enabled</b> —Enables the BOOTP protocol. <b>Disabled</b> —Disables the BOOTP protocol.
<b>Default</b>	Enabled
<b>Effectivity</b>	The CrownNet interface must be reset for changes to take effect. Use the Administration/Communications/xxxxxxx NIC/ CrownNet/Common/Soft Reset menu (where xxxxxxxx is either Resident or Optional).

## **Disabling the RARP Protocol**

The RARP menu allows you to enable or disable the RARP protocol.

<b>Menu</b>	Administration/Communications/Resident NIC/CrownNet/ TCPIP/Protocol/RARP Administration/Communications/Optional NIC/CrownNet/ TCPIP/Protocol/RARP
<b>Choices</b>	<b>Enabled</b> —Enables the RARP protocol. <b>Disabled</b> —Disables the RARP protocol.
<b>Default</b>	Enabled
<b>Effectivity</b>	The CrownNet interface must be reset for changes to take effect. Use the Administration/Communications/xxxxxxx NIC/ CrownNet/Common/Soft Reset menu (where xxxxxxx is either Resident or Optional).

## **Configuring SNMP Information**

SNMP (Simple Network Management Protocol) is a standard protocol used to monitor devices and the networks to which they attach. (See appendix C, “SNMP and TCP/IP Concepts,” for more information on SNMP.)

The SNMP NMS 1, SNMP NMS 2, SNMP NMS 3, SNMP NMS 4, SNMP NMS 5 menus allow you to identify and configure up to five Network Management Stations (NMSs)—NMS 1 through NMS 5. You must provide the following information about each NMS that you want to be able to access the printer: Internet address, community name, and access.

## **Specifying a Community Name**

A community is a group of SNMP agents managed by an NMS, and a community name is associated with a specific NMS address. For the NMS to gain access to the device, the correct community name (up to 15 characters in length) must be supplied when connecting.

<b>Menu</b>	Administration/Communications/Resident NIC/CrownNet/TCP/IP/SNMP NMS x/Community Administration/Communications/Optional NIC/CrownNet/TCP/IP/SNMP NMS x/Community
<b>Choices</b>	Up to 15 characters
<b>Default</b>	public
<b>Effectivity</b>	The CrownNet interface must be reset for changes to take effect. Use the Administration/Communications/xxxxxxx NIC/CrownNet/Common/Soft Reset menu (where xxxxxxxx is either Resident or Optional).

## **Specifying an Internet Address**

The Internet Address option allows you to set the IP (internet protocol) network address for the NMS so the printer can communicate with the network. Traps, if enabled, are sent to this address. The address has the form 000.000.000.000. See appendix C, "SNMP and TCP/IP Concepts," for more information on internet addresses.

<b>Menu</b>	Administration/Communications/Resident NIC/CrownNet/TCP/IP/SNMP NMS x/Internet Address Administration/Communications Optional NIC/CrownNet/TCP/IP/SNMP NMS x/Internet Address
<b>Choices</b>	Each triplet can have a value of 000-255
<b>Default</b>	000.000.000.000
<b>Effectivity</b>	The CrownNet interface must be reset for changes to take effect. Use the Administration/Communications/xxxxxxx NIC/CrownNet/Common/Soft Reset menu (where xxxxxxxx is either Resident or Optional).
<b>Notes</b>	000.000.000.000 is a wildcard address that allows any host to connect to the printer using the defined community name.

### Guidelines

Keep the following guidelines in mind when setting the Internet Address:

- The address must consist only of numbers and periods. Selecting a letter or another symbol results in an error message.
- Any xxx value between 10 and 99 must begin with 0 (for example, 10 is entered as 010 and 99 is entered as 099).
- Any xxx value between 1 and 9 must begin with 00 (for example, 1 is entered as 001 and 9 is entered as 009).

### Specifying Access Information

The Access option provides security for the SNMP by configuring the privileges associated with each NMS. See appendix C, "SNMP and TCP/IP Concepts," for more information on traps.

<b>Menu</b>	Administration/Communications/Resident NIC/CrownNet/ TCPIP/SNMP NMS x/Access Administration/Communications/Optional NIC/CrownNet/ TCPIP/SNMP NMS x/Access
<b>Choices</b>	<b>None</b> —The NMS isn't configured. Other configured NMS's can still access the printer via SNMP. <b>Read</b> —The NMS can read all SNMP variables. <b>Read-Trap</b> —The NMS can read all SNMP variables and receive traps. <b>Trap</b> —Traps are sent to the NMS (if defined) when printer errors occur. <b>Write</b> —The NMS can read all SNMP variables as well as set the ones so defined. <b>Write-Trap</b> —The NMS can read all SNMP variables, set the ones so defined, and receive SNMP traps on printer errors.
<b>Default</b>	Write
<b>Effectivity</b>	The CrownNet interface must be reset for changes to take effect. Use the Administration/Communications/xxxxxxx NIC/CrownNet/Common/Soft Reset menu (where xxxxxxx is either Resident or Optional).

# Setting the Binary Communications Protocol

- » **Note:** *Binary communications protocol (BCP) is not available on some printers. However, if it is available on your printer, the PS Protocol menu appears in all interface menus. Check your printer documentation for availability.*

The PS Protocol menu allows you to set the binary communications protocol (BCP) for communicating with a PostScript printer over the CrownNet interface. BCP allows any 8-bit binary value (0-255) to be treated as data, while still allowing a few of the values to function as special control characters.

<b>Menu</b>	Administration/Communications/Resident NIC/PS Protocol Administration/Communications/Optional NIC/PS Protocol
<b>Choices</b>	<p><b>Binary</b>—Enables quoted binary communications protocol (BCP) over serial and parallel interfaces. Print jobs can change this setting through PostScript operators. Data in the printable ASCII range also prints. Use the special quoting mechanism (see the following section) for the special characters and ^D (EOF).</p> <ul style="list-style-type: none"><li>» <b>Note:</b> <i>Binary provides only raw data, not quoted BCP, over the CrownNet interface.</i></li></ul> <p><b>Binary Fixed</b>—Enables binary communications protocol (BCP). Print jobs cannot change this setting through PostScript operators. Data in the printable ASCII range also prints. Use the special quoting mechanism (see the following section) for the special characters and ^D (EOF).</p> <ul style="list-style-type: none"><li>» <b>Note:</b> <i>Binary Fixed provides only raw data, not quoted BCP, over the CrownNet interface.</i></li></ul> <p><b>Normal</b>—Enables standard, ASCII (7-bit) hex protocol over serial, parallel, and CrownNet interfaces. Data is sent and received in ASCII format. This mode is recommended if you do not print binary data. It was designed for data in the printable ASCII range. Print jobs can change this setting through PostScript operators.</p>

## Setting the Binary Communications Protocol

	<p><b>Normal Fixed</b>—Enables standard, ASCII (7-bit) hex protocol over serial, parallel, and CrownNet interfaces. Print jobs cannot change this setting through PostScript operators.</p> <p><b>QBinary</b>—Enables quoted binary communications protocol (BCP) over the CrownNet interface only. Print jobs can change this setting through PostScript operators. Data in the printable ASCII range also prints. Use the special quoting mechanism (see the following section) for the special characters and ^D (EOF).</p> <p><b>QBinary Fixed</b>—Enables quoted binary communications protocol (BCP) over the CrownNet interface only. Print jobs cannot alter change this setting through PostScript operators. Data in the printable ASCII range also prints. Use the special quoting mechanism (see the following section) for the special characters and ^D (EOF).</p>
<b>Default</b>	Normal
<b>Effectivity</b>	Once you put the printer back on line, changes to this menu take effect for the next job received over the interface.
<b>Notes</b>	<p>A data stream sent through the CrownNet interface using QBinary or QBinary Fixed is treated the same as a data stream sent through the serial or parallel interface using Binary or Binary Fixed, respectively. In other words, QBinary and QBinary Fixed let you take a file quoted for Binary or Binary Fixed over the serial or parallel interface and send it to the printer over the CrownNet interface.</p> <p>A data stream sent through the CrownNet interface using QBinary or QBinary Fixed is not treated the same as a data stream sent through the same interface using Binary or Binary Fixed. QBinary and QBinary Fixed are used to send quoted BCP files over the CrownNet interface while Binary and Binary Fixed are used to send raw files over the CrownNet interface.</p>

## Setting the Binary Communications Protocol

<b>Notes</b> (cont.)	<p>If Binary is enabled for the CrownNet interface, you must use the QMS <b>%%Session</b> DOC to concatenate multiple subjobs since the PostScript ^D separator is a feature of only the Normal and QBinary modes. The <b>%%Session</b> DOC is not needed, however, if a binary job, consisting of only a single PostScript file, is sent over the CrownNet interface.</p> <p>If multiple files of different languages are concatenated into one image over CrownNet or sent independently over parallel/serial, only the PostScript files are affected by quoting/BCP. Do not quote CCITT images, for example.</p>
----------------------	---

### Quoting Mechanism

When communicating 8-bit binary data in binary or binary fixed mode, the printer uses the quoting mechanism of the binary communications protocol to distinguish between the special control characters and print job binary data.

To differentiate data from the special control characters, any data that is the same as one of the following special control characters must be quoted.

ASCII Keyboard	ASCII Name	ASCII Hex	Control Function
^A	SOH	0x01	Quote data character
^C	ETX	0x03	Abort job and flush to end of file
^D	EOT	0x04	End-of-file marker
^E	ENQ	0x05	(Reserved for future use)
^Q	DC1	0x11	XON in XON/XOFF flow control
^S	DC3	0x13	XOFF in XON/XOFF flow control
T	DC4	0x14	Job status request
^\ (Reserved for future use)	FS	0x1C	

A data byte is quoted by replacing it with a two-character sequence. The first character is a ^A (ASCII hex 0x01), and the second character is the character itself XORed with the ASCII value 0x40. For



## **Setting the Binary Communications Protocol**

example, to send the value 0x14(^T) as data, send the two-character sequence 0x01 0x54 (^a T) instead. (ASCII "T" is the result of XORing ^T with 0x40).

This method of quoting guarantees that whenever the printer receives any of the eight control characters, the control function is intended regardless of whether the preceding character is a ^A. Any data byte not equal to one of the eight special control characters is transmitted by sending the data byte.

For more information on BCP and quoting, see the *PostScript Language Reference Manual* (Adobe Systems, Inc., Reading, MA: Addison-Wesley, 1990, ISBN 0-201-18127-4), the "Adobe Serial and Parallel Communications Protocols Specification" (in *Adobe Developer Support*. Adobe Systems, Inc., February 14, 1992), and the "PostScript Language Reference Manual" (in *Supplement for Version 2011*, Adobe Systems, Inc., January 24, 1992).

### **Advantages**

The main advantage of using the Binary, Fixed Binary, QBinary, and QBinary Fixed PS protocol modes when sending binary data is that these modes allow compressed data streams. Since compressed documents are smaller than uncompressed documents, you can send smaller jobs to the printer. For example, some device drivers can format bitmapped images as binary data instead of as ASCII hex-encoded data, which is twice as large.

### **Implementation**

To implement PS protocol for sending binary data on your system you need a special device driver available with some applications or operating systems, or you can alternatively use a program to read the data and write out the quoted characters. See your QMS vendor for any available information on device drivers or binary filter programs.

# Setting the Default Job Priority

- » **Note:** *Job priority is not available on some printers. However, if it is available on your printer, the Def Job Prio menu appears in all interface menus. Check your printer documentation for availability.*

The Def Job Prio menu allows you to specify which jobs are printed first, according to the interface through which they are received, when jobs are received simultaneously. In other words, you can give jobs received via the CrownNet interface priority over jobs received via the parallel and serial interfaces.

<b>Menu</b>	Administration/Communications/Resident NIC/CrownNet/ Interface/Def Job Prio Administration/Communications/Optional NIC/CrownNet/ Interface/Def Job Prio
<b>Choices</b>	001-100 (highest-lowest priority)
<b>Default</b>	001 (highest priority)
<b>Effectivity</b>	Changes to this menu take effect as soon as you put the printer back on line.



# 3

---

## **CrownAdmin for DOS**

---

### **In This Chapter . . .**

- “Opening CrownAdmin” on page 3-2
  - “Using Remote Console” on page 3-2
  - “Closing CrownAdmin” on page 3-4
-

# Introduction

This chapter explains how to open and close CrownAdmin for DOS on the PC and how to access Remote Console.

- » **Note:** *CrownAdmin for DOS only works with CrownNet version 2.05 or earlier versions.*

## Opening CrownAdmin

Use the following procedure to open CrownAdmin for DOS:

- 1 Make sure the CrownAdmin directory is in the path, or change to the CrownAdmin directory.**

If necessary, refer to your DOS manual for information on editing the DOS **path** command in the AUTOEXEC.BAT file.

- 2 At the DOS prompt, type**

```
cadm4dos␣
```

## Using Remote Console

Remote Console allows you to access printer information and change printer configuration settings from anywhere on the network.

### Accessing Remote Console

Use the following procedure to access Remote Console. If necessary, choose the Help button to see on-line help.

- 1 In the list of printers, double-click on the printer name.**
  - » **Note:** *If the appropriate printer isn't displayed in the list, rescan the network for available printers by choosing Re-Scan from the Scan menu or by choosing the Re-scan button on the toolbar. Also, verify that filters are not preventing the printer name from being listed.*
  - 2 To open Remote Console, use one of the following methods:**
    - From the Display menu choose Run Remote Console, or
    - Choose the Remote Console button on the toolbar.
  - » **Note:** *If Remote Console is not supported on the selected printer, the menu entry and button are grayed out.*
- CrownAdmin closes the dialog box and opens a terminal window for the Remote Console session. Refer to the *QMS Crown Remote Console User's Guide* for more information on using Remote Console.

## **Multiple Remote Console Sessions**

You can open multiple Remote Console sessions on multiple printers, depending on the amount of memory available on your PC. To open another Remote Console window while one is already open, repeat the steps listed in "Accessing Remote Console."

When multiple Remote Console windows are open, the title of each window contains the printer's name (for example, "QMS 4525 Remote Console").

## **Closing a Remote Console Session**

There are two ways to close a Remote Console session:

- Type `quit` at the prompt.
- Click the Remote Console window's control box and select close.

# **Closing CrownAdmin**

Use the following procedure to close CrownAdmin:

- Double-click on the control box, or
- From the control box menu choose Close.



# 4

---

## CrownAdmin 3

---

### In This Chapter . . .

- “About CrownAdmin 3” on page 4-3
  - “Windows 95 and Windows NT” on page 4-4
  - “Solaris/SunOS, AIX, and HP-UX” on page 4-4
  - “OS/2” on page 4-4
  - “Macintosh” on page 4-4
  - “Using the Online User's Guide” on page 4-8
  - “Using Remote Console” on page 4-13
-

# Introduction

After presenting an overview of CrownAdmin 3 for Windows, AIX, HP-UX, Solaris, and SunOS, this chapter explains how to open and close CrownAdmin 3 and how to access the online user's guide.

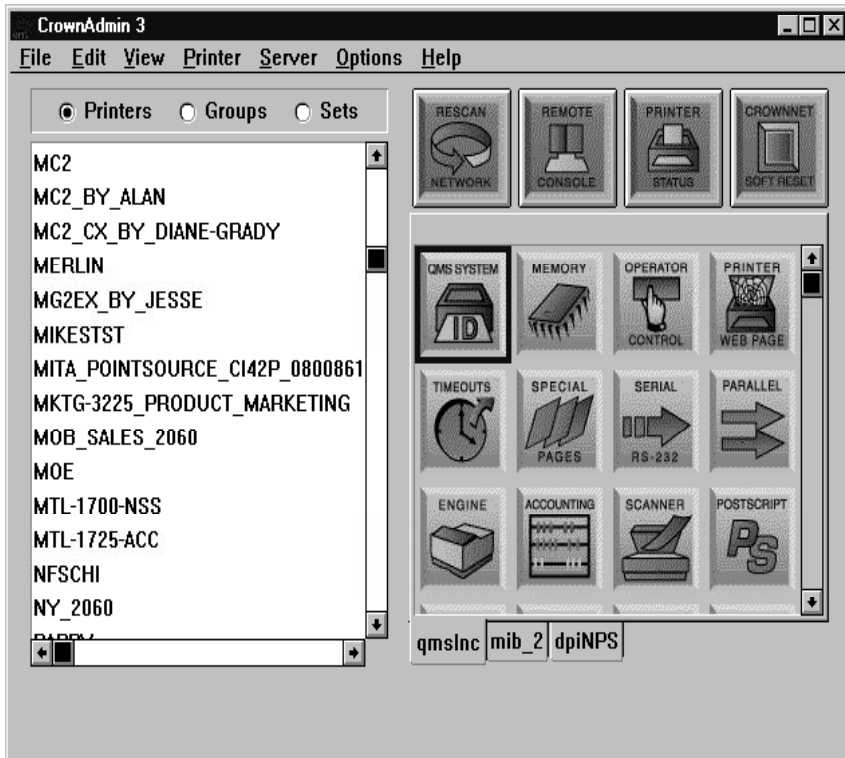



## **About CrownAdmin 3**

CrownAdmin is a software utility that allows you to monitor and configure QMS printers and perform network operations on printers connected to Ethernet or Token-Ring. Some of the things you can do through CrownAdmin 3 include the following:

- Configure network protocols on the printer interface daughter-board.
- Configure printer parameters
- Define groups of printers with common characteristics so you can easily make global configuration changes.
- Use SNMP (where available) for retrieving and setting up printer information.
- Download printer system software, fonts, forms, etc.
- Control PostScript files through the PS Utilities dialog box.
- Format and print files.
- Check printer status.
- Configure settings on the printer.
- Use QMS Remote Console.
- Create and edit group-configuration templates.

For more information, see the CrownAdmin 3 online help. Instructions for accessing the user's guide can be found later in this chapter.

## **Opening CrownAdmin 3**

- » **Note:** *In NetBEUI/NetBIOS environments, there is an autodiscovery mode in which printers are polled, so you'll notice a short delay when opening CrownAdmin.*

## **Windows 95 and Windows NT**

Double-click the CrownAdmin 3 icon in the CrownAdmin 3 group.

## **Solaris/SunOS, AIX, and HP-UX**

**1 Make sure the CrownAdmin 3 executable directory is in the path, or change to the crnadm directory.**

**2 Type**

`./crnadm`

» **Note:** *For information on the UNIX Host Software, see chapter 6, "UNIX Utilities."*

## **OS/2**

Use one of the following procedures to open CrownAdmin 3 for OS/2:

■ **Double-click on the CrownAdmin 3 icon.**

or

■ **Select the CrownAdmin 3 icon, and then from the File menu choose Open.**

## **Macintosh**

Open CrownAdmin 3 for Macintosh OS as you would any Macintosh application:

■ **Double-click on the CrownNet icon, or**

■ **Select the CrownNet icon, and then from the File menu choose Open.**

All of the utilities are located in CrownAdmin 3's Network menu.

## **Setting the EtherTalk Zone**

CrownNet supports the Phase 2 EtherTalk protocol, which allows multiple logical zones on a single network. Although each network device may be assigned to only one of these zones, it can service different

zones. A zone is a subgroup of users within a larger group of inter-connected networks. Because you can have up to 64K nodes on an EtherTalk network, it's common to divide larger networks into zones to reduce traffic.

Use the following procedure to attach a printer to and detach a printer from a specific zone. If necessary, choose the Help button to see on-line help.

**1 From the Network menu, choose Set EtherTalk Zone...**

CrownNet scans the network for available printers and zone names, and then displays the information in a dialog box. The shortcut for this command is Command-Z.

**2 In the Printers box, select the appropriate printer by clicking on its name.**

The Printers box lists all available printers. Each printer name is followed by an @character and the name of the zone to which it is attached.

» **Note:** *If the appropriate printer doesn't display in the Printers box, click the Scan... button to rescan the network for available printers.*

**3 In the EtherTalk Zones box, select the appropriate zone name.**

The EtherTalk Zones box shows the list of available EtherTalk zones in the network.

» **Note:** *If the appropriate zone doesn't display in the EtherTalk Zones box, click the Scan... button to rescan the network for available zones.*

**4 If necessary, type a password in the Password box.**

The system administrator sets this password on the printer.

**5 Choose the Set button to set the zone name (that is, attach the selected printer to the selected zone).**

The zone name takes effect immediately, and the new *printer@zone* name is displayed in the Printers box.

- 6 Click the Scan... button to rescan the network for available printers.**

The printer must reset itself after the zone is changed, so rescanning is necessary to display the reset printer in the Printers box.

- 7 Choose the Done button to return to the CrownNet window.**

## **Using Filters**

Since CrownNet supports Phase 2 Ethernet, which allows multiple logical zones on a single network, and because you have up to 64K nodes on an EtherTalk network, it may be difficult to find a particular printer. The Filters option helps you locate a printer on the network.

- 1 From the Options menu choose Preferences...**
- 2 In the Filter Specification box, type the name of the printer.**
  - The maximum length of the name is 32 characters.
  - The = wildcard character matches all possible characters (for example, = alone specifies all printers in the selected zone[s], and m= selects all printers starting with "m.")
  - The ≈ wildcard character matches any or no characters. For example, m≈g selects printers named "mg," "meg," "mktg," "marketing," and so on.
- 3 In the EtherTalk Zones box select a zone name.**
  - To select a single zone, click on it.
  - To select a range of zones, click on the first one then hold down the Shift key and click on the last one.
  - To select several noncontiguous zones, click on the first one and then hold down the Option key and click on each other zone.
- 4 In the Max. Scan Time box type the maximum number of seconds you want the system to look for printers.**

The range is 5-300 seconds. The default is 5 seconds.

- 5 In the Max. Printer Entry box, type the maximum number of printers you want to display in the list box.**

The range is 64-1000. The default is 64.

- 6 By default, zones as well as printers are scanned. If you do not want zones scanned, deselect Rescan Zones.**
- 7 Click OK to return to the CrownAdmin 3 desktop.**

## **Naming the Printer**

Your printer's default name on a network is the model, such as the QMS 2425 Print System. However, each printer on an EtherTalk network must have a unique name. CrownNet provides a utility to set the printer name if more than one printer of the same model is on the network.

Use the following procedure to set the printer's name. If necessary, choose the Help button to see on-line help.

- 1 From the Network menu choose Set Printer Name.**

The shortcut for this procedure is Command-N.

- 2 In the box at the top of the dialog box, select the printer you want to rename.**

» **Note:** *If the appropriate printer doesn't display in the box, click the Scan... button to rescan the network for available printers.*

- 3 Type a new name for the printer in the New Name box.**

All characters except : and @ are valid.

- 4 Click the Scan... button to rescan the network for available printers.**

The printer must reset itself after name is changed, so rescanning is necessary to display the renamed printer in the Printers box.

- 5 Choose OK.**

# **Using the Online User's Guide**

The on-line user's guide contains complete information on using CrownAdmin 3.

## **Accessing the Online User's Guide**

You can access the user's guide in these ways:

- In the main CrownAdmin 3 window, from the Help pull-down menu choose Contents.
- In any CrownAdmin 3 dialog box, choose the Help button.

## **Finding Information in the On-Line User's Guide**

Once a Help window is displayed on the screen, you can find information in the following ways:

- Click on a highlighted topic. (To return to the previous window, from the Navigate menu choose Go Back.)
- Click on the Section box to display the current topic and the parent topics of the current topic. Click on any topic in the list to go there.
- To find information on a particular topic, from the Navigate menu choose Table of Contents or Search to find keywords in an topic.
- Use the left or right arrow keys to browse through the topics.
- For more information, from the Help menu choose Help on the Browser.

## **Viewing Multiple Help Topics**

To view more than one help topic at a time, from the File menu in the Help window, choose New Browser.



# Configuring the Interface and the Printer

Use the array of buttons located on the lower right of the main CrownAdmin 3 screen. When you click on one of the printer configuration buttons this area will change to the “Edit Settings” area. You can then edit and change the printer configuration setting based on the button you selected.





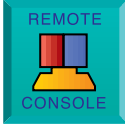
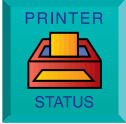

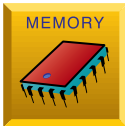

## Configuration Buttons

The configuration buttons on the right side of the main CrownAdmin 3 window can be used to choose network interface configurations and printer configurations. This table gives you a brief overview of each button. For more information on printer configurations see your printer documentation.

- » **Note:** *The appearance and function of some of these buttons depend on the options installed on your printer.*



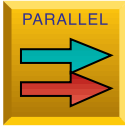







Button	Description	Button	Description
	Use this button to update your list of printers in the main window.		Use this button to start a Remote Console session with the selected printer.
	Use this button to open a status window for the selected printer.		Use this button to reset the CrownNet interface or to put interface configuration changes into effect

## Configuring the Interface and the Printer

Button	Description	Button	Description
	Use this button when TCP/IP protocol is available to access printer and interface information.		Use this button to access memory configuration values.
	Use this button to access operator control configurations for the selected printer.		Use this button to access the built-in printer web page settings.
	Use this button to access timeout configurations for the selected printer.		Use this button to access configurations for special pages on the selected printer.
	Use this button to access configurations for the serial (RS-232) interface on the selected printer.		Use this button to access configurations for the parallel interface on the selected printer.
	Use this button to access configurations for printer engine on the selected printer.		Use this button to access configurations for accounting on the selected printer.





## Configuring the Interface and the Printer

Button	Description	Button	Description
	Use this button to access configurations for an optional Crown-Copy scanner on the selected printer.		Use this button to access PostScript configurations on the selected printer.
	Use this button to access configurations for the HP-GL emulation on the selected printer.		Use this button to access configurations for the HP-PCL emulation on the selected printer.
	Use this button to access configurations for the LN03 emulation on the selected printer.		Use this button to access configurations for the QUIC emulation on the selected printer.
	Use this button to access configurations for the line printer emulation on the selected printer.		Use this button to access configurations for the TIFF emulation on the selected printer.
	Use this button to access configurations for the CALC emulation on the selected printer.		Use this button to access configurations for the CGM emulation on the selected printer.

## Configuring the Interface and the Printer

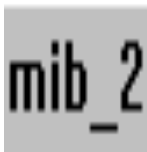
Button	Description	Button	Description
	Use this button to access configuration options on CrownNet versions 1.x.		Use this button to access configuration options on CrownNet versions 3.x and above.
	Use this button to access configurations for the EtherTalk interface on the selected printer.		Use this button to access configurations for the TCP/IP interface on the selected printer.
	Use this button to access configurations for NetBEUI/NetBIOS on the selected printer.		Use this button to access configurations for SNMP on the selected printer.
	Use this button to access printer system identification information for the selected printer.		Use this button to access information about the jobs the selected printer is processing.
	Use this button to access administration configurations for the selected printer.		

Button	Description	Button	Description
	Use this button for configuring QMS print systems that are CrownNet enabled.		Use this button for statusing QMS and other vendors' print systems via the standard MIB.
	Other buttons can appear representing other vendors. Use this button to configure products that support a particular MIB.		

- » **Note:** *When accessing the input and output trays on the selected printer, you must add a 1 to each tray number to select the correct tray. Normally, the trays on QMS printers are numbered consecutively (1,2,3). From CrownAdmin 3 you must access these trays as 2, 3, 4. See your printer documentation for more information on input and output tray numbers.*

## Using Remote Console

Remote Console allows you to access printer information and change printer configuration settings from anywhere on the network.

- » **Note:** *After using Remote Console on the Macintosh, close the Remote Console session. You will not be able to print over the network until the Remote Console session has ended.*

## **Accessing Remote Console**

Use the following procedure to access Remote Console. If necessary, choose the Help button to see on-line help.

**1 Select the appropriate printer.**

- » **Note:** *If the appropriate printer doesn't display in the Printers box, click the Scan... button to rescan the network for available printers.*

**2 From the Printer menu choose Remote-Console (or click the Remote Console button).**

CrownAdmin 3 opens a terminal window for the Remote Console session. Refer to the *QMS Crown Remote Console User's Guide* or the CrownAdmin 3 online user's guide for more information on using Remote Console.

As with other Macintosh application windows, you can use the zoom box and the resize box to change the window size.

## **Multiple Remote Console Sessions**

You can open multiple Remote Console sessions on multiple printers, depending on the amount of memory available on your computer.

- To open another Remote Console window while one is already open, from the Network menu choose Remote-Console again.

When multiple Remote Console windows are open, the title of each window contains the printer's name (for example, "QMS 4060 Remote Console").

## **Closing a Remote Console Session**

There are three ways to close a Remote Console session:

- Type `quit` at the prompt.
- Choose Close from the File menu.
- Click the Remote Console window's close box.

# **Closing CrownAdmin 3**

To close CrownAdmin 3, from the File menu, choose Exit.

Close CrownAdmin 3 for Macintosh as you would any Macintosh application:

- Click the close box, or
- From the File menu choose Quit.





# 5

---

## **CrownNet Manager for OS/2**

---

### **In This Chapter . . .**

- “Overview of CrownNet Manager for OS/2” on page 5-2
  - “Opening CrownNet Manager for OS/2” on page 5-3
  - “Using CrownNet Manager” on page 5-4
  - “Additional Technical Notes” on page 5-8
-

# Introduction

This chapter explains how to open and use CrownNet Manager for OS/2 on a workstation to monitor and customize your OS/2 printing environment, and how to install and use the QMS CrownNet Print Utility for Windows.

## Overview of CrownNet Manager for OS/2

CrownNet Manager for OS/2 is installed on the server to enable printing to QMS Crown printers with a QMS CrownNet interface. It supports the following OS/2 server software:

- IBM LAN Server 1.3 and later, running under OS/2 1.2 or later
- Microsoft LAN Manager 2.0c or later, running under OS/2 1.2 or later

The following figure shows how CrownNet Manager for OS/2 functions in the printing process.

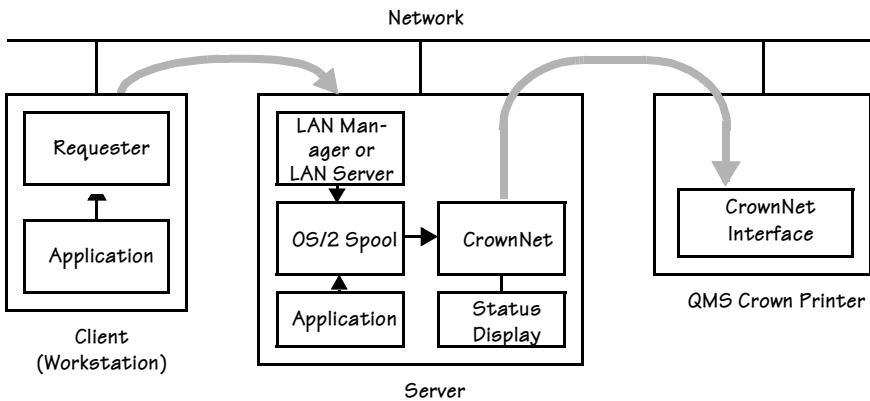



## **Printing Directly to the Printer**

It's possible to bypass the server and send print jobs from your workstation directly to the printer. This procedure cuts down on network traffic because the jobs are spooled on your workstation rather than on the server.

The following information will help you print directly to the printer.

- Make sure OS/2 and workstation software are installed on the workstation.
- Install CrownNet Manager for OS/2 on your workstation, using the server installation procedure in the *QMS CrownNet Setup Guide*.
- Make sure you use the QMS printer driver rather than the IBM-NULL printer driver.

# **Opening CrownNet Manager for OS/2**

Use one of the following procedures to open CrownNet Manager for OS/2:

- **Double-click on the CrownNet icon.**
- or
- **Select the CrownNet icon, and then from the File menu choose Open.**

## **Using CrownNet Manager**

The CrownNet Manager for OS/2 shows the current status of each installed port of the attached printer (for example, if a printer error has occurred). If many printers have been installed, you can scroll through the list by using the scroll bar or the PgUp/PgDn keys.

Each port of a printer is displayed as QMS\_*hwaddress*, where *hwaddress* is the CrownNet interface's hardware address (Administration/Communications/Networkx/CrownNet/Common/HW Address menu). The factory-default hardware address is 080086xxxxxx. See chapter 2, "Printer Configuration," for more information on hardware addresses.

The following menus are available in the action bar:

- Help
- Install
- Logfile
- Remove
- Status

### **Using the Help Menu**

Use the commands in the Help menu to access detailed on-line help for the menus, commands, and actions available in CrownNet Manager for OS/2 as well for the fields in the status and log file displays.

- 1 From the Help menu choose Help index...**
- 2 Double-click on the appropriate topic.**
- 3 When you have finished using help, close the help window as usual.**

## **Using the Install Menu**

Use the Install menu to register newly attached CrownNet printers:

**1 From the Install menu choose Install.**

All available CrownNet printers (those operating and on line) are displayed in the Installation of CrownNet Ports dialog box. They may be identified by their default hardware addresses (QMS\_080086xxxxxx). Hardware addresses are set in the Administration/Communications/Networkx/CrownNet/Common/HW Address menu. See chapter 2, "Printer Configuration," for more information.

**2 Select a CrownNet printer or use the Select All button to select all listed printers.**

**3 Choose Install.**

## **Using the Logfile Menu**

CrownNet Manager for OS/2 updates a log file, named CROWN-MAN.LOG, each time a significant event occurs (for example, a file is printed). This file is stored in the Crown directory on your PC in plain text format.

- » **Note:** *The following line in the STARTUP.CMD file specifies the name and location of the log file:*

```
set crownman=c:\crown
```

*This line must be placed after the line*

```
net start server
```

### **Erasing the Log File**

From the Logfile menu choose Erase to erase the log file.

### **Printing the Log File**

Open the log file in any text editor and then print it as you would normally print a file.

## **Turning Truncation On and Off**

By default, the log file is truncated to save hard disk space. If you want to record every event, select Auto-truncate to turn off truncation. Truncation is selected when a checkmark appears next to the command.

## **Viewing the Log File**

There are two ways to view the log file:

- From the Logfile menu choose View.
- Use any text editor.

## **Using the Remove Menu**

Use this menu to remove individual CrownNet printers that will not be used:

### **1 Choose Remove.**

If no CrownNet printers are available for removal, a message box displays: *Nothing to Remove!* Click OK to return to the CrownNet Manager window.

### **2 Select the appropriate printer from the list that is displayed.**

### **3 Select Remove.**

### **4 Select Yes when asked to confirm the removal.**

- » **Note:** *Ports linked to print queues cannot be removed. Detach them from their respective print queues first.*

To reregister printers, use the Install menu.

## **Using the Status Menu**

The status display provides the following information for each installed port of the attached printer:

- **Port number**—The port number is identified as QMS\_*hwaddress*, where *hwaddress* is the CrownNet interface's

hardware address (Administration/Communications/Networkx/  
CrownNet/Common/HW Address menu). The factory-default  
hardware address is 080086xxxxxx. See chapter 2, "Printer Con-  
figuration," for more information on hardware addresses.

- **Status**—The status may be identified as OK, Internal error, Printing, or No response.

No response is reported if the printer is off, the protocol is dis-  
abled, or the printer name has changed.

- » **Note:** *CrownNet Manager requires OS/2 Presentation Manager for its status display.*

## **Refreshing the Status Display**

Normally, CrownNet Manager for OS/2 refreshes the status display every minute. However, you can choose Refresh to update the display immediately.

## **Switching Between the Status and Log Files**

When the log file is displayed, from the Status menu choose Refresh to switch to a display of the status file.

## **Viewing the Status File**

To display more information about a specific CrownNet printer, use the following procedure:

- 1 In the status display, select a printer.**
- 2 From the Status menu choose Details.**

The CrownNet Port Details dialog box lists the following information about the CrownNet printer: network, port, status, product, software version, and software date.

- 3 When you are finished, click OK to return to the CrownNet Manager for OS/2 window.**

## **Closing CrownNet Manager**

To close the CrownNet Manager for OS/2, double-click on the control box.

## **Additional Technical Notes**

- CrownNet Manager for OS/2 does not support printing from LAN Server if NetBIOS-over-TCP/IP is activated because NetBIOS-over-TCP/IP completely replaces the NetBEUI protocol stack. Printing from LAN Server is fully supported if NetBEUI is used.
- NetBEUI must be enabled in LAN Manager. NetBEUI and TCP/IP can be enabled and active at the same time.
- There is no definite limit to the number of CrownNet interface's supported by each server. Each CrownNet interface is seen as a separate destination by a print queue and, in turn, by an application. However, if many CrownNet interfaces are installed on the network, the maximum number of NetBIOS sessions may have to be increased in the NetBEUI setup.
- CrownNet Manager for OS/2 is completely transparent and does not affect the data stream that passes through it. From an application point of view, CrownNet Manager for OS/2, the CrownNet interface, and printer together behave as though the printer is directly attached to the server.
- Opening CrownNet Manager for OS/2 more than once on a server can cause the server to hang.



# 6

---

## **CrownNet Print Utility for Windows: Microsoft Windows Network Support**

---

### **In This Chapter . . .**

- “Setting Up Serverless Printing” on page 6-3
  - “Setting Up Client-Server (Server-Based) Printing” on page 6-3
  - “Getting Help” on page 6-4
-

# Introduction

The QMS CrownNet Print Utility for Windows is a dual-purpose application for serverless or client-server (server-based) network printing in a Windows environment. It provides two functions:

- Installs and maintains CrownNet ports as Windows printer ports.
- Captures and monitors print jobs directed to CrownNet LAN Manager/LAN Server (NetBIOS/NetBEUI) ports.

## Requirements

The QMS CrownNet Print Utility for Windows is compatible with all CrownNet-equipped printers running with LAN Manager/LAN Server enabled (Administration/Communications/Networkx/CrownNet/Lan Manager/Protocol menu). This utility operates over the NetBIOS/NetBEUI protocol from the following Windows environments:

- Windows 3.1—with LAN Server/LAN Manager Workstation Service
  - Windows for Workgroups 3.11, Windows NT 3.5 and above, or Windows 95—with Microsoft Windows Network (Microsoft NetBEUI protocol)
- » **Note:** *The Print Manager must be activated in all Windows environments. In addition, the Microsoft NetBEUI protocol must be installed and operational prior to the installment of the QMS CrownNet Print Utility for Windows. Refer to your Windows documentation for installation and configuration instructions.*

## Installation

Refer to the *QMS CrownNet Setup Guide* or the appropriate directory on the CD-ROM for installation instructions.



# Setting Up Serverless Printing

After you have used one of the procedures in the *QMS CrownNet Setup Guide* to install the print utility, your network printers will be directly available from any Windows application.

You can do a quick check of the setup by choosing Print or Print Setup from the File menu of any Windows application. If the Printer field shows the *drive:\directory\port* entry or *Printer Name* on *Nexx* you created, you're ready to begin printing directly to your Crown printer's resident print server. If the Printer field shows anything else, such as *Printer Name* on *LPTx: [Local Port]*, you'll either need to reconfigure the Windows default printer or select the CrownNet Windows port name within your printing application.

## Setting Up Client-Server (Server-Based) Printing

After choosing a Microsoft Windows Network server and installing your CrownNet ports on the server, use the Print Manager's Share function to make the network printers available to other users (Microsoft Windows Network clients). Your network printers will now be available from any Windows application.

### Notify Option

When enabled, the CrownNet notify option (from the Option menu choose Notify) informs you when Windows has successfully completed the transfer (not printing) of your print job to the remote CrownNet printer, Windows server, or Windows client (peer) station. If you want to verify that your jobs have successfully printed, use CrownAdmin's Remote Console. This utility shows jobs in the printer's queue and a history of recently completed printed jobs.

## Getting Help

### Refresh Option

Use the CrownNet Print Utility's Refresh command to obtain printer status updates manually. This list shows the currently installed Windows ports and their current status. The list is automatically updated every 15 seconds, but you can use Refresh to update it at any time.

## Getting Help

Choose Help in the CrownNet Print Utility for on-line help on how to use the utility. A QMS customer support list is also available in the on-line help.



# 7

---

## UNIX Utilities

---

### In This Chapter . . .

- “Setting the Internet Address” on page 7-2
  - “QMS qpr Command” on page 7-5
  - “FTP (File Transfer Protocol)” on page 7-8
  - “Password Files” on page 7-11
  - “Host Address Files” on page 7-14
  - “Printing and Transferring Files” on page 7-21
  - “QMS LPD (Line Printer Daemon)” on page 7-24
  - “HP-UX Versions 9.x and 10.x” on page 7-27
-

# Introduction

The QMS UNIX Host Software supports many varieties of UNIX, including the following:

- AIX Version 4.1
- HP-UX Versions 9.x and 10.x
- Sun Solaris Version 2.5
- SunOS Version 4.1.2
- SCO Build 10
- SGI Version 5.3
- SYS V Release 3

This chapter lists the main differences between HP-UX Versions 9.x and 10.x, describes the BOOTP and RARP protocols (which allow you to set the printer's Internet address), explains how to use the QMS **qpr** command to print files, provides the information you need to use the QMS implementation of FTP (File Transfer Protocol), and discusses QMS LPD (Line Printer Daemon) support.

## Setting the Internet Address

The printer's Internet (network) address is in the format xxx.xxx.xxx.xxx. It must be set, and it must be unique. There are three ways to set the Internet address:

- The Administration/Communications/xxxxxxxx NIC/Crown-Net/TCP/IP/Internet Address submenu (where xxxxxxxx is either Resident or Optional), explained in chapter 2, "Printer Configuration."
- The bootp protocol, explained in the following section. "The bootp Protocol."
- The rarp protocol, explained later in "The rarp Protocol."

## The bootp Protocol

The Bootstrap Protocol (bootp) is an application-level protocol used for reading operating environment parameters (such as the Internet address) at printer startup.

- 1 If necessary, update the system host table by adding the following line to the `/etc/hosts` file:**

```
internetaddress hostname↵
```

where *internetaddress* is the Internet address of the printer and *hostname* is the name of the host.

- 2 If necessary, update your alias name databases (Yellow Pages and YP/NIS).**

Use the `cd /var/yp` and `make` commands.

- 3 Add the following single line to the boot table (usually, the `/etc/bootptab` file) on your host:**

```
hostname: ht=type: vm=format: ha=hardadd:  
ip=intadd: sm=submask: gw=router
```

Use the following table to find the appropriate information with which to replace the variables in this line:

This field...	uses this variable.	Replace the variable with...
Host Name	<i>hostname</i>	the name of the host
ht Hardware Type	<i>type</i>	the hardware type: ether—Ethernet token—Token-Ring
vm Vendor Magic	<i>format</i>	the bootp report format— usually, this should be <code>rfc1048</code>
ha Hardware Address	<i>hardadd</i>	the printer's Ethernet or Token-Ring address
ip Internet Address	<i>intadd</i>	the printer's Internet address
sm Subnet Mask	<i>submask</i>	the subnet mask value
gw Gateway	<i>router</i>	the default router (gateway) address

## Setting the Internet Address

- 4 Start the bootp daemon (if it isn't already running). Usually, the command is

```
bootpd↓
```

However, this command is system dependent. Consult your system documentation.

- 5 Restart the printer to download the Internet address, default router (gateway) address, and subnet mask.

## The rarp Protocol

The Reverse Address Resolution Protocol (rarp) is a low-level transport layer protocol that reads the Internet address at printer startup. The following procedure explains how to use rarp to set the printer's Internet address:

- 1 If necessary, update the system host table by adding the following line to the `/etc/hosts` file:

```
internetaddress hostname↓
```

where *internetaddress* is the Internet address of the printer and *hostname* is the name of the host.

- 2 If necessary, update your alias name databases (Yellow Pages and YP/NIS).

Use the `cd /var/yp` and `make` commands.

- 3 Add the following line to the Ethernet Address table (usually, the `/etc/ethers` file) on your host:

```
xx:xx:xx:xx:xx:xx name↓
```

where *xx:xx:xx:xx:xx:xx* is the hardware address of the printer and *name* is the printer name.

- 4 Start the rarp daemon (if it isn't already running). Usually, the command is

```
rarpd -a↓
```

However, this command is system dependent. Consult your system documentation.

**5 Restart the printer to read the Internet address.**

- » **Note:** *To disable bootp or rarp protocol, select the TCPIP button in the main CrownAdmin 3 window. Select the protocol in the options list and select disable in the edit settings window.*

## **QMS qpr Command**

If you're printing files over TCP/IP, the QMS **qpr** command can be used to send files to your QMS printer.

### **Syntax**

To use the command, type

```
qpr options file
```

where *options* is replaced by the appropriate options from the following table and *file* is the file you want to print.

### **Options**

The following options are available for the QMS **qpr** command.

- » **Note:** *Not all options are supported by all QMS printers.*

-# <i>n</i>	Prints <i>n</i> copies of the document. Note that this does not pass the value to the spooler as the argument for its copies function.
-B <i>value</i>	Draws a border around the page spot which is <i>value</i> pixels in width.
-c	Enables collation (if supported by your printer) when multiple copies are requested.
-C <i>option</i>	Scales the logical page to fit within its page spot. <i>option</i> can be on or off.
-d	Prints the document in duplex mode (if supported by your printer).
-D <i>string</i>	Includes <i>string</i> in the Document Option Command data.

**QMS qpr**  
**Command**

-f <i>title</i>	Changes the title of the document (file) on the header page to <i>title</i> . The default title is the name of the file.
-F <i>left top</i>	Specifies the offsets of the logical page within its page spot. Offsets are positive or negative displacements from the edges in decipoints ( <sup>1</sup> /720").
-g <i>fn cycle unit</i>	Requests that filename <i>fn</i> (a printer-resident file) be compiled and displayed as the background image of the job. If <i>cycle</i> is "1" the background image prints only on the first page of the job. If cycle is "*" the background image is repeated for each page of the job. If <i>unit</i> is "sheet" (background image to a sheet face) the background job is mapped onto the physical sheet using formats specified by the image file. If <i>unit</i> is "page" (background image to a logical page), the background job is mapped onto the logical page using formats specified by the job.
-G <i>col row sp order</i>	Determines the number and size of page spots per sheet ( <i>col</i> is the number of columns per sheet, <i>row</i> is the number of rows per sheet, and <i>sp</i> is the space between columns), and the logical order in which logical pages should be placed within the page spots.
-h <i>option</i>	Turns the header page on or off for the current print job. <i>option</i> can be on or off.
-H <i>source</i>	Specifies the input bin to be used for the header page. Bins are the same as for <b>-l</b> .
-i <i>type</i>	Identifies the physical size of the paper supported by the printer and/or controller. <i>type</i> can take the following values: Letter, Legal, Ledger, Executive, A5, A4, A3, B5, and B4.
-l <i>bin</i> [l is a capital i]	Identifies the number of the input bin containing the paper to be used: 1, 2, 3, 4, manualfeed, or "*" (the quotation marks are mandatory). The "*" requests any available input bin of the specified paper size ( <b>-i type</b> ) except the manual feed tray.  » <b>Note:</b> Available input bins vary, depending on your printer.



## QMS qpr Command

-K # <i>fold mar thick</i>	Prints the job in booklet format. # specifies the number of sheets of paper making up the booklet. <i>fold</i> specifies the direction of the fold (vertical/horizontal). <i>mar</i> specifies the distance between the logical page and the fold. <i>thick</i> is the thickness of the paper being used in <sup>1</sup> / <sub>10</sub> mils (in other words, in increments of <sup>1</sup> / <sub>10,000</sub> " ).
-l <i>language</i> [l is a lowercase L]	Specifies the language or emulation (such as hpgl or pcl) to be used by the printer to interpret the document. This should correspond to the language used in preparing the document. Refer to your printer documentation for information on supported languages and emulations.
-ls [l is lowercase L]	Invokes landscape orientation.
-m	Sends notification via mail(1) when the print job completes. This option is passed to the local system spooler, and it is the spooler's responsibility to effect the notification.
-M <i>left top rt bot alt</i>	Specifies the margins which encompass all marks printed on a given sheet for all sheets of a given document. Margins are displacements from the edges of the sheets measured in decipoints ( <sup>1</sup> / <sub>720</sub> " ). <i>left</i> is the left margin, <i>top</i> is the top margin, <i>rt</i> is the right margin, <i>bot</i> is the bottom margin, and <i>alt</i> is the alternate margin.
-o <i>bin</i>	Identifies the number or logical name of the output bin to be used: 1, 2, 3, <i>name</i> , or "*" (the quotation marks are mandatory). The "*" requests any available face-down output bin.  » <b>Note:</b> <i>Available output bins vary, depending on your printer.</i>
-p	Invokes portrait orientation.
-P <i>printer</i>	Sends the file(s) to <i>printer</i> . If <i>printer</i> is omitted, the file(s) is sent to the user's default printer as given by the PRINTER environment variable for BSD systems or by the system default destination for SYSV systems.
-r <i>resolution</i>	Uses the print resolution or dot density of <i>resolution</i> . Available resolutions are product dependent.

## FTP (File Transfer Protocol)

-R <i>lpage lpage</i>	Specifies a range of logical pages to print. You may use "*" (the quotation marks are mandatory) for <i>lpage</i> to indicate the end of the document. The default setting is 1 "*" (the quotation marks are mandatory).
-S <i>type</i>	Selects the size of the logical page mapped to the physical sheet of paper to be used by the current print job. The values of <i>type</i> are the same as for -i.
-t	Prints the document in tumble duplex mode (if supported by your printer).
-tr <i>option</i>	Turns the trailer page on or off for the current print job. This option can be on or off.
-ts <i>option</i>	Specifies the input bin to be used for the trailer page. Bins are the same as for -i. This option must be used with -tr.

### Notes

- The number of copies to be printed and the duplexing parameters may be overridden by specifications within the document itself. Refer to your printer user's guide for availability of specific features. Also refer to your *QMS Crown Document Options Commands* manual for the correct DOC syntax.
- The local system spooler, lpr(1) or lp(1), is assumed to reside along the invoker's path.
- **qpr** terminates the DOCs it adds to the beginning of the file with the command %%EndComments. DOCs that are already coded within a file prior to printing with **qpr** will not be parsed as DOCs when sent by **qpr** because of this terminating command.

## FTP (File Transfer Protocol)

The usual implementations of FTP are designed to transfer files from host to host. The QMS TCP/IP implementation is designed to allow the transfer of files from a host to an FTP server in a QMS Crown printer. This makes it easy for you to do tasks such as log on the

## FTP (File Transfer Protocol)

printer, check the number of jobs in the print queue, list the available fonts, and send files to the printer.

While FTP is an interactive program that requires you to log on the printer before sending commands, these commands can be entered into a UNIX shell script or a PC batch file that executes the commands automatically. In this way, a continuous check of the printer job queue, for example, can be done by writing a script that loops around the appropriate FTP commands.

### Supported FTP Commands

Since several FTP commands are not applicable to a printing environment, the QMS implementation supports a printer-related subset of the standard FTP commands. Because requests for information such as job status or a list of current fonts are not explicit FTP commands, other methods are used to obtain this type of information. These methods are described later in this chapter.

It is important to note that all versions of FTP are not identical. However, the following commands are supported by most implementations of FTP, including the QMS implementation:

Use this command...	to...
<i>cd directory</i>	change to the specified printer directory
<i>close</i>	terminate the ftp session
<i>dir</i>	list the contents of the current printer directory
<i>get</i>	receive a file from the printer
<i>help</i>	list commands that are currently supported by the FTP server
<i>ls</i>	list the contents of a directory (filenames only)
<i>mput filenames</i>	send multiple files to the printer
<i>open</i>	open an ftp session on the printer
<i>put filename</i>	send one file to the printer
<i>pwd</i>	display the full pathname or the current printer directory
<i>quit</i>	exit from FTP
<i>type filetype</i>	specify whether the system is to interpret print files as binary or ASCII data

## FTP (File Transfer Protocol)

### Logging in to a Printer via FTP

When you connect to a QMS Crown printer using FTP, you can interactively request information from the printer as well as send data to the printer to be printed or stored.

To log in to a printer, type either

```
ftp printername↵
```

(where *printername* is the host name of the printer to which you want to connect) or

```
ftp ipaddress↵
```

(where *ipaddress* is the IP address of the printer to which you want to connect).

### Example

The host in this example is identified as unix, and the printer is identified as chaucer:

```
[unix, 227] ftp chaucer↵  
Connected to chaucer.  
220 QMS CrownNet Rev x.x  
220 QMS 1725E System; Release 1.1; Firmware 1;  
Processor R3081; CROWN 0; ready.  
Name (chaucer:brian): root↵  
331 User name ok, need password  
Password: ↵  
230 User logged in  
ftp>
```

### Exiting from a Printer via FTP

To exit from the printer and close the FTP connection, at the prompt type

```
quit↵
```

- » **Note:** *The close command also allows you to exit from the printer, but FTP remains active.*

**Example**

```
ftp> quit.␣
221 Goodbye
unix 2]
```

# Password Files

If the printer has a hard disk, you can secure the files on the hard disk through the use of passwords. Installing a password file is a three-step procedure:

- Create the password file
  - Download the password file
  - Turn the printer off and restart it for the passwords to take effect
- » **Note:** *If you have a security key for your printer, you can set an Administration menu password for the special administrative account "root" via the printer control panel.*

**Create the Password File**

Create the password file on the local host. The password file must be named PASSWD.FTP. The format of the password file is

```
account1:password1
account2:password2
account3:password3
...
```

- 
- ▲ **Caution:** *Since passwords are encrypted, keep the original password file in a secure place on the host computer.*
-

### Download the Password File

- 1 Make sure the Administration/Communications/*xxxxxxx* NIC/CrownNet/TCPIP/Secure Files (where *xxxxxxx* is either Resident or Optional) option is disabled.

See chapter 2, "Printer Configuration," for complete information.

- 2 Make sure the printer's hard disk is configured correctly.
- 3 Log in to the printer as root.
- 4 Type `cd admin` to change to the admin directory.
- 5 Type `put passwd.ftp` to copy the password file to the admin directory on the printer's hard disk.

» **Note:** *If there is no hard disk or if the hard disk is not correctly configured, the following message is displayed: Can not open file on printer.*

**Example**—In this example, the user has already completed steps 1-3 above.

```
ftp> cd admin
250 Chdir okay
ftp> put passwd.ftp
200 PORT command okay
150 Opening connection
226 Transfer complete
local: PASSWD.FTP remote: passwd.ftp
37 bytes sent in 0.025 seconds (1.4 Kbytes/s)
ftp> quit
221 Goodbye
unix 5]
```

### Restart the Printer

Once you have downloaded the password file, turn the printer off and back on again for the passwords to take effect.

## Logging In with a Password

Once the passwords are in effect, users are prompted for a password when they log in to the printer.

### Example—Incorrect Password

This example shows what happens when you try to log in with an incorrect password (notice that the password does not appear on the screen when you type it). The host in this example is identified as `unix`, and the printer is identified as `chaucer`:

```
unix 6] ftp chaucer
Connected to chaucer.
220 QMS CrownNet Rev. x.x
220 QMS 1725E System; Release 1.1; Firmware 1;
Processor R3081; CROWN 0; ready.
Name (chaucer:brian): jess↵
331 User name ok, need password
Password:    ↵
530 Login failed
ftp> quit↵
unix 7]
```

### Example—Correct Password

This example shows what happens when you log in with a correct password (notice that the password does not appear on the screen when you type it). The host in this example is identified as `unix`, and the printer is identified as `chaucer`:

```
unix 8] ftp chaucer
Connected to chaucer.
220 QMS CrownNet Rev. x.x
220 QMS 1725E System; Release 1.1; Firmware 1;
Processor R3081; CROWN 0; ready.
Name (chaucer:brian): jess↵
331 User name ok, need password
Password:    ↵
230 user logged in
ftp>
```

## **Listing the Contents of the Password File**

Use the UNIX **cat** command to list the contents of the original **PASSWD.FTP** file on the host system:

```
unix 9] cat password.ftp
jess:newark
brian:wilmington
karen:whonoz
ken:deerfield
janice:mobile
melissa:elibom
```

## **Host Address Files**

If your printer has a hard disk, you can ensure that only host computers with one of the specified Internet addresses are allowed access to the printer through the use of a host address file. Installing a host address file is a three-step procedure:

- Create the host address file.
- Download the host address file to the hard disk.
- Turn off and restart the printer for the host addresses to take effect.

### **Create the Host Address File**

Create the host address file on the local host. The host address file must be named **HOST.EQ**. The format of the host address file is

```
192.009.200.001
192.009.300.003
192.009.300.006
```



## **Download the Host Address File**

- 1 **Make sure the Administration/Communications/xxxxxxx NIC/CrownNet/TCPIP/Secure Files option (where xxxxxxxx is either Resident or Optional) is disabled.**

See chapter 2, "Printer Configuration" for complete information.

- 2 **Make sure the printer's hard disk is configured correctly (see "Identifying Hard Disks," later in this chapter).**
- 3 **Log in to the printer as root.**
- 4 **Type `cd admin` to change to the admin directory.**
- 5 **Type `put host.eq` to copy the host address file to the admin directory on the printer's hard disk.**

» **Note:** *If there is no hard disk or if the hard disk is not correctly configured, the following message is displayed: Can not open file on printer.*

**Example**—In this example, the user has already completed steps 1-3 above.

```
ftp> cd admin.↵
250 Chdir okay
ftp> put host.eq.↵
200 PORT command okay
150 Opening connection
226 Transfer complete
local: host.eq remote: host.eq
37 bytes sent in 0.025 seconds (1.4 Kbytes/s)
ftp> quit.↵
221 Goodbye
unix 14]
```

## **Restart the Printer**

Once you have downloaded the host address file, turn the printer off and back on again for the file to take effect.

## **Listing the Contents of the Host Address File**

Use the UNIX **cat** command to list the contents of the original HOST.EQ file on the host system:

```
unix 16] cat host.eq↵  
192.009.200.001  
192.009.300.003  
192.009.300.006
```

## **Directory Commands**

This section describes the following commands:

- **pwd**—Displays the current (working) directory
- **cd**—Changes directories
- **dir**—Lists the contents of a directory

### **Displaying the Current Directory (pwd)**

To determine the current (working) directory, type **pwd**.↵

#### **Example**

```
ftp> pwd↵  
257 "usr" is the current directory.  
ftp>
```

### **Changing Directories (cd)**

To change directories, use the **cd** command:

- Type **cd *directoryname***.↵ to change to a directory with the name *directoryname*.
- Type **cd /**.↵ to return to the printer root directory.

In both situations, the message 250 CWD command successful displays on your monitor.

## **Listing the Contents of a Directory (dir)**

To list the contents of a directory, type `dir`.

**Example**—This example lists the directories available in the printer's root directory. The following sections of this chapter describe these printer directories in more detail.

```
ftp> dir
200 PORT command successful
150 Opening data connection for dir
    (161.33.128.1.7.107) (0 bytes), (mode ascii.

admin
disk
help
no_doc_cmds
usr

226 Transfer complete.
28 bytes received in 0.01 seconds (2.7 Kbytes/s)
ftp>
```

# **Printer Directories**

The following printer directories are available.

- » **Note:** *Putting a file to any directory other than ADMIN, DISK, and USR causes the file to print.*

## **ADMIN Directory**

Only users logged in as root have access to this directory. The HOST.EQ and PASSWD.FTP files are stored in this directory.

You can **put** files to or **get** files from this directory. To **get** a file, you must know the filename in advance.

- » **Note:** *Typing `dir` in this directory produces the error message `invalid dir command`.*

## **DISK Directory**

Only users logged in as root have access to this directory. The printer's hard disk(s) are accessed through this directory.

You can **put** files to or **get** files from any physical subdirectory. The complete pathname must be specified.

- » **Note:** *Typing `dir↓` in this directory produces the error message `invalid dir command`.*

## **HELP Directory**

After changing to this directory (`cd help↓`), type `dir↓` to list the commands supported by the server.

- » **Note:** *This list differs according to whether you are logged in with or without "root" privileges.*

**putting** a file to this directory causes the file to print. On the printed file's header page and in the JOBS directory under Remote Console, the filename is displayed in the **%%Title:** field, and your FTP logon name is used in the **%%For:** field.

## **NO\_DOC\_CMDS Directory**

**putting** a file to this directory causes the file to print. On the printed file's header page and in the JOBS directory under Remote Console, the filename is displayed in the "Title:" field, and your FTP logon name is used in the "For:" field.

The QMS Document Option Commands (DOC) **%%Title** and **%%For** override the default "Title:" and "For:" fields. However, FTP printing requires that jobs using **%%Title** and **%%For** commands be **put** to the printer interface's NO\_DOC\_CMDS directory. If jobs are **put** to any other directory, these commands are ignored. (See the *QMS Document Option Commands* manual for more information about DOCs.)

In the two examples below, the user (scottc) has included the following DOCs at the beginning of the file SCOTTC.TXT, which is **put** to two different printer directories:

```
%!  
%%Title: Scottc Title  
%%For: Scottc For  
%%Routing: Scottc Routing  
%%IncludeFeature:header(on)trailer(off)  
%%End Comments
```

**Example 1**—In this example, the user (scottc) puts the file SCOTT.C.TXT to a printer directory other than NO\_DOC\_CMDS:

```
ftp> put scottc.txt↵  
200 PORT command successful  
150 Opening data connection for scottc.txt  
    (161.33.128.1.7.107), (mode ascii.  
226 Transfer complete  
local:scottc.txt remote: scottc.txt  
10457 bytes sent in 0.009 seconds  
    (1.1e+02 Kbytes/s)  
ftp>
```

When the job is printed, the following information is included on the header page. Notice that the default job owner (the name under which the user logged in: scottc) and the default job title (scottc.txt) are used. The %%Title and %%For DOCs are ignored, but the %%Routing DOC is interpreted correctly.

**Example 2**—In this example, the user (scottc) puts the file SCOTT.C.TXT to the NO\_DOC\_CMDS directory:

```
ftp> cd no_doc_cmds↵  
250 CWD command successful.  
ftp> put scottc.txt↵  
200 PORT command successful.  
150 Opening data connection for scottc.txt  
    (161.33.128.1.7.107), (mode ascii.  
226 Transfer complete  
local:scottc.txt remote: scottc.txt  
10457 bytes sent in 0.04 seconds  
    (2.6e+02 Kbytes/s)  
ftp>
```

## Printing and Transferring Files

When the job is printed, the following information is included on the header page. Notice that the information given in the **%%For** and **%%Title** DOCs overrides the default job owner and job title.

```
emulation
JOB #
Scottc Title
For:           Scottc For
Routing:       Scottc Routing

Submit queue:  Ethernet
Submitted      0:36:32
Started:       0:36:32
```

### USR Directory

You can **put** files to or **get** files from this directory. To **get** a file, you must know the filename in advance.

- » **Note:** *Typing `dir` in this directory produces the error message `invalid dir command`*

# Printing and Transferring Files

Four commands—**type**, **put**, **mput**, and **get**—allow you to work with printer files.

### type Command

The **type** command allows you to check or set the file transfer mode. Its function depends on whether or not you include a filetype after the command:

<b>Syntax</b>	<b>type</b>
<b>Purpose</b>	Checks the current filetype

<b>Syntax</b>	<b>type filetype</b>
---------------	----------------------

## Printing and Transferring Files

<b>Purpose</b>	Sets the type of data contained in the file to be <b>put</b> (sent) to the printer.
<b>filetype</b>	binary—For 7-bit or 8-bit binary data ascii—For other data
<b>Notes</b>	This command changes the way the host sends data, not how the interface receives the data. From the host's point of view, the primary difference between binary and ASCII files is the way carriage returns and line feeds (<CR> and <LF>) are handled  Binary—<CR>=<CR> and <LF>=<LF> ASCII—<CR>=<CR>+<LF> and <LF>=<LF>+<CR>

**Example**—In this example the **type** command changes the transfer mode to binary:

```
ftp> type binary␣
200 Type set to I
ftp>
```

## put and mput Commands

The **put** command allows you to send a file to the printer for printing or storage. The **mput** command allows you to send multiple files to the printer for printing or storage.

<b>Syntax</b>	<b>put filename</b> <b>mput filenames</b>
<b>Purpose</b>	<b>put</b> sends a file to the printer or downloads the file to the printer's hard disk.  <b>mput</b> sends several files to the printer or downloads several files to the printer's hard disk.
<b>filename</b>	The filename(s). If the files are not in the host's root directory, use the full pathname. Wildcards are acceptable with the <b>mput</b> command.

## Printing and Transferring Files

<b>Notes</b>	<p>You can use the <b>put</b> or <b>mput</b> command in any directory. However, to <b>put</b> or <b>mput</b> files to a hard disk, you must be in the ADMIN, DISK, or USR directory. (If you are not already in the directory, the file prints.)</p> <p>Only users with “root” privileges can <b>put</b> or <b>mput</b> files to the ADMIN and DISK directories. The ADMIN directory assumes that the path is SYS:/ADMIN), but you must change to the USR directory before you can <b>put</b> or <b>mput</b> files there:</p> <pre>ftp&gt; put filename SYS:/usr/files/filename.↓</pre> <p>If you attempt to <b>put</b> or <b>mput</b> files to the printer while the printer is off line, you are told that the printer is off line, and then FTP waits until the printer is placed back on line to send the file(s).</p>
--------------	--

**Example**—In this example all of the files in the current directory are **mput** (sent) to the printer:

```
ftp> mput *.*↓
mput file.ext? y↓
200 PORT command successful
150 Opening data connection for file.ext
(161.33.128.1.7.107), (mode binary).
226 Transfer complete
mput file2.ext? y↓
200 PORT command successful
150 Opening data connection for file.ext
(161.33.128.1.7.107), (mode binary).
local file2.ext remote: file2.ext
226 Transfer complete.
10457 bytes sent in 0.04 seconds
(2.6e+02 Kbytes/s)
ftp>
```



## **get Command**

The **get** command allows you to transfer files from the printer to the host.

<b>Syntax</b>	<b>get filename</b>
<b>Purpose</b>	Transfers files from the printer's hard disk to the host.
<b>filename</b>	The name of the file as it appears on the printer's hard disk. If the file is not in the host's root directory, use the full pathname.
<b>Notes</b>	If the current directory is ADMIN, only users with "root" privileges can <b>get</b> files. The USR directory assumes that the path is DSK7:/USR, DSK6:/USR, or DSK5:/USR (whichever is applicable). However, if you are in the DISK directory, you must give the entire path for <i>filename</i> . For example,  ftp> <b>get SYS:/admin/passwd.ftp password.</b>

**Example**—This example shows how to **get** (transfer) *filename* from the printer to the host:

```
ftp> get file3.ext.
200 PORT command successful
150 Opening data connection for file.ext
    (161.33.128.1.7.107), (mode binary).
local file3.ext remote: file3.ext
226 Transfer complete.
10457 bytes sent in 0.04 secondsd
    (2.6e+02 Kbytes/s)
ftp>
```

# **QMS LPD (Line Printer Daemon)**

The QMS LPD (Line Printer Daemon) allows your printer to appear as a remote UNIX print system to all supported BSD LPD-capable systems. The Berkeley remote print system is supported by many hosts and is easy to configure. It must be RFC 1179 compliant.

- » **Note:** *The QMS LPD does not support any of the optional command line parameters used by lp or lpr.*

## **Configuring the Host to Use the QMS LPD**

Before you can use the QMS LPD to provide print job spooling, you must make the following configuration changes on the host:

- Modify the TCP/IP host table in the host's /etc/hosts file.
- Modify the printer's entry in the host's /etc/printcap file.
- » **Note:** *Some systems do not use /etc/printcap for configuration. See your UNIX system documentation for the equivalent commands.*

### **Modifying the TCP/IP Host Table**

The TCP/IP host table on the BSD system is normally found in the /etc/hosts file. You must modify this table to associate the printer's Internet address with its TCP/IP network node name.

- » **Note:** *The printer's Internet address is set in the Administration/Communications/xxxxxxx NIC /CrownNet/TCP/IP/Internet Address menu (where xxxxxxxx is either Resident or Optional). (See chapter 2, "Printer Configuration," for more information.)*

For example, if the printer's Internet address is 192.009.200.140 and its TCP/IP network node name is "qms," you would add the following line to the /etc/hosts file:

```
192.9.200.140          qms
```

- » **Note:** For systems running the Domain Name Service (DNS), this Internet address/node name pairing should also be added to the DNS administrative database files. (See your UNIX documentation for more information.)

## Modifying the Printcap Entry

The printer capability file is normally `/etc/printcap`. The UNIX `lpr` command looks for this file each time a print request is made. Therefore, there must be an entry in this file corresponding to the printer's TCP/IP network node name in the TCP/IP host table. For example, if you use the same node name as in the previous example, "qms," you would add the following entry to the `/etc/printcap` file.

```
QMS|QMS Printer:\
:lp=:\
:sd=/usr/spool/anyqueue:\
:rm=qms:\
:rp=anyqueue
```

In this entry, QMS is the host queue name, `lp` specifies the device to which you are printing (it is undefined here since you are printing remotely), `sd` stands for "spool directory," `qms` is the name of the printer (`rm` stands for "remote machine") in the host's TCP/IP host table (identified in the previous section), and `anyqueue` is the printer queue name (`rp` stands for "remote printer").

## Using LPD

Once you have modified the necessary host files, you can use the UNIX `lpr` command to print a file (and take advantage of the QMS LPD):

```
lpr -PQMS filename
```

"QMS" is the host queue name you specified in the `/etc/printcap` file. If the `-P` option is not used, `lpr` uses the printer specified in the `PRINTER` environment variable or the default `lp`.

The QMS LPD observes the spooling options (Spooling On, Spooling On Input Idle, and Spooling On Idle) currently set in the Administration/Communications/xxxxxxx NIC/CrownNet/Common/Spooling printer menu (where xxxxxxxx is either Resident or Optional).

## Monitoring Status

### Using LPC

LPC is a UNIX utility that allow the system administrator to enter several UNIX printer control commands through a single command. After you add the QMS queue to the /etc/printcap file, the UNIX command

```
lpc status
```

should return the following message:

```
QMS:
      queueing is enabled
      printing is enabled
      no entries
      no daemon present
```

### Using LPQ

The UNIX **lpq** command requests a job queue display similar to the following:

```
Printer Status:NO ERROR
Job # Queue Title User I/F Status
12 QMS chapl.ps Brian Ethernet Spooling 0 of 0
13 QMS pix.ps Jess Ethernet Printing 1 of 1
```

Notice that the Queue name reported is the name you defined in the **rp** field in the host's /etc/printcap file.

If no jobs exist in the queue, the following message displays:

```
Printer Status:NO ERROR
```

or

```
Printer Status:IDLE
```

In the event of an error on the printer, the **NO ERROR** message in the Printer Status field is replaced with the same message displayed in the printer's control panel message window.

# HP-UX Versions 9.x and 10.x

Because the QMS UNIX Host Software supports HP-UX Versions 9.x and 10.x, this section lists the major differences between HP-UX Version 9.x and HP-UX Version 10.x. For more complete information see Hewlett-Packard's *Release Notes for HP-UX 10.x*.

- The minimum memory configuration for Version 10.x is 16 MB.
- Version 10.x uses a new file system layout based on the industry-standard Novell USL and OSF/1 (often called a V.4 file system).

In particular, file/directory locations and system startup/shutdown control have changed. Source files, shell scripts, binaries, build and test environments, documentation, and environmental variables with embedded pathnames may be affected by these file and directory location changes.

- The file system table **/etc/checklist** is not **/etc/fstab**.
- The default location for users' home directories has changed from **/users** to **/home**.
- Version 10 supports the following new HP 9000 computers: Series 800 Model K and Series 700 Model J.
- Version 10 supports all Series 700/800 computer's running Version 9.x **except** the following:
  - Series 700 (Models 705, 710, 730, and 750)
  - Series 600/800 (Models 635SV, 645SV, 808, 815, 822S, 825S, 832S, 835S, 835SE, 840S, 842S, 845S, 850S, 852S, 855S, 860S, 865S, 870S/100, 870S/200/300/400)
  - Any Series 800 with an 8 MB memory card in the first slot.
- Version 10.x provides HP Software Distributor, a new tool for installing and updating software
- In Version 10.01 and later, NFS Diskless replaces Version 9.x's DUX Diskless. Neither NFS Diskless nor DUX Diskless is supported in Version 10.0.





# 8

---

## Printer Web Page

---

### **In This Chapter . . .**

- “Using the Printer Web Page” on page 8-2
  - “Types of Printer Web Pages” on page 8-3
  - “Web Page Help System” on page 8-13
-

# Introduction

Inside your new QMS printer resides an HTTP (Hyper-Text Transfer Protocol) based web page that can be accessed from the most common web browser software, that is, Netscape Navigator and Microsoft Explorer. This web page gives you access to the most frequently accessed printer configurations and gives you instant access to printer status. Anyone on your company intranet can access the QMS printer through their web-browser software.

This section provides you with details on

- Setting up and using the web page
- The different types of pages in the printer
- Accessing QMS web site and the web-help system

## Using the Printer Web Page

Setting up the printer web page to run on your intranet involves three basic steps:

- Assigning a name to your printer
- Setting up the “no proxy” preferences in your browser software
- Using the name of the printer to access the web page from your browser software

### Assigning a Printer Name

The printer web page can only be accessed through the assigned name of the printer or the IP address. It may be more convenient for you to use a name rather than the address.



## **Setting Up Your Browser Software**

Since your printer will reside on your intranet and will not be accessible beyond the firewall of your network, you must set up the proper “preferences” in your browser software. Your printer name must be added to the “no proxy” list in the preference options of the browser. See “Accessing the Web Page”, section of the CrownNet Setup Guide for specific procedures on setting up your browser software.

## **Types of Printer Web Pages**

Your QMS printer web page works very much like any other HTML (Hyper-Text Markup Language) page that you can access on the World Wide Web. Each page has hypertext links that will take you to another related page within the printer web pages. On some pages you will find forms that contain radio buttons (used for selecting an option), text boxes (used for entering options), list boxes (used to select one among a group of options), and submit or clear buttons (used to send the data entered to the printer).

The following sections contain samples of QMS printer web pages that will give you some idea of how your printer web pages will look. The graphics, forms, and configuration data will vary for different printer model web pages.

## Types of Printer Web Pages

### Home Page

The Home Page is the starting point for all access to the printer web pages. On this page you can find hotlinks to all of the supporting web pages for your printer. This example shows the home page for the QMS 3260 Print System

QMS 3260 Print System / QMS 3260 Print System - Microsoft Internet Explorer

File Edit View Go Favorites Help

**QMS** Welcome to QMS

<a href="#">Home</a>	<a href="#">Operator Control</a>	<a href="#">General Settings</a>	<a href="#">Printer Jobs</a>	<a href="#">Consumable Status</a>
<a href="#">Accounting</a>	<a href="#">Statistics</a>	<a href="#">QMS, Inc.</a>	<a href="#">Online help</a>	<a href="#">System support</a>

Product Name: QMS 3260 Print System
Printer Name: QMS 3260 Print System
Online status: <b>Online</b>

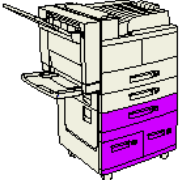

Current Status IDLE

Resolution: 600 DPI / Standard

Default Inputbin: Letter / Upper / 35 %

Default Output: Upper

Sheets printed: 5601

Faces printed: 7112

t

## **Operator Control Page**

The Operator Control hotlink on the home page jumps to the Operator Control page. This page contains a form which allows you to view or configure settings in your printer.

- » **Note:** *When you submit changes to this form, the printer must be online.*

## **General Settings Page**

The General Settings Page contains links to different groups of printer configuration settings. This information can be viewed to show you the status of the printer but it can not be changed. To change these settings you must access the printer's configuration through the front panel of the printer, remote or local console, or through CrownAdmin 3.

## **Printer Jobs Page**

The Printer Jobs hotlink on the home page will jump to the Printer Jobs page. This page contains information about the current jobs the printer is processing and information on the previous five jobs printed.

## **Consumable Status Page**

The Consumable Status hotlink on the home page will jump to the Consumable Status page. This page contains information about the usage and level of consumables that the printer is using (such as paper and toner).

## **Accounting Page**

The Accounting hotlink on the home page will jump to the Accounting page. This page shows you if accounting is enabled and information about the accounting disk space and file segment.

## **Statistics Page**

The Statistics hotlink on the home page allows you to check the amount of usage for printer consumables, such as the number of sheets, faces and planes printed as well as the average coverage of toner.

- » **Note:** *The number of sheets/faces printed statistics differ from the number of sheets printed statistics on the printer's start-up and status pages, which refer to the total number of sheets/faces of media printed during the life of the printer.*

## **QMS, Inc. Page**

The QMS, Inc. hotlink on the home page will jump to the QMS web site configured on the System Support page. From the QMS web site you can access information about other QMS printers, contact information, a FAQ database, printer manuals, and online performance support.

## **Online Help Page**

The Online Help hotlink on the home page will jump to any help information that has been selected on the System Support Page. You can configure this to jump to your own help web site set up on your local intranet. You can also configure this to jump to the QMS web-based online help system for your QMS print system.

## **System Support Page**

The System Support hotlink on the home page will jump to the System Support and Password Page. This page can be used to set up internal support for the printer as well as links to the QMS web site.

- » **Note:** *When you submit changes to this form, the printer must be online.*

# Web Page Help System

Your printer web page is supported with help and support tools located at the QMS web site. When you click on the Help button on the printer home page you will be linked to an HTML page located at the QMS web site. From here you can link to topic which applies to your specific problem.

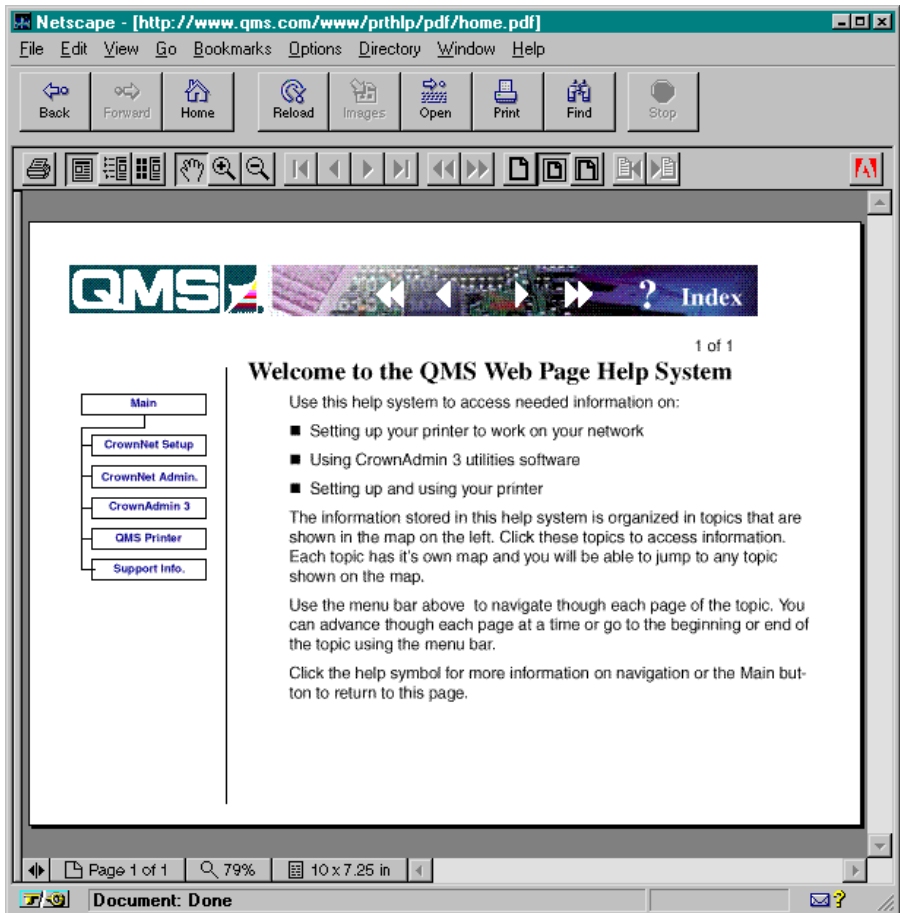

# **Email Notification on Printer Error**

This feature provides email notification to a specified user when the printer encounters an error (such as paper out).

You have the option of selecting when the message is sent. Once an email message has been sent, another email message is sent when the error condition has been cleared.

## **Configuration**

To use the email notification feature, you must configure the SMTP parameters using either CrownAdmin or CrownView.

### **CrownAdmin**

To configure the SMTP parameters in CrownAdmin, update the MIB. Otherwise, use CrownView.

### **CrownView Printer WebPage**

To configure parameters in CrownView, the SMTP parameters in CrownView, access the System Support Page.

The SMTP configuration items are accessed via the “help” page, which is selected from the “Online Printer help” link on the initial page.

## Email Notification on Printer Error

- » **Note:** The asterisks (\*) indicate the required SMTP Parameters.

**System support**

Select the desired page refresh rate :  Off  15 Sec.  30 Sec.  60 Sec.  5 Min.

If you need assistance, contact:

Contact Number:

Printer help URL:

QMS Corporate URL:

For Product or Dealer Information:

SMTP Mail Server Address: \*

SMTP Sender's Domain: \*

Sender's address: \*

To: \*

CC (Separated by commas):

Subject:

When to send email on printer error:  Off  1 Min.  30 Min.  1 Hr.  Test

Email sent via: Resident NIC

*\* Indicates Required SMTP Parameter*

- » **Note:** You have the option of selecting when the email is sent after the error condition has occurred. You may also select "Test" which sends an email immediately and allows you to test the settings without creating a printer error.







# 9

---

# Troubleshooting

---

## In This Chapter . . .

- “General Problems” on page 9-2
  - “CrownAdmin 3 for Windows, Solaris/SunOS, AIX, and HP-UX Problems” on page 9-4
  - “EtherTalk Problems” on page 9-5
  - “OS/2 LAN Manager/LAN Server Problems” on page 9-7
  - “NetWare Problems” on page 9-8
  - “TCP/IP Problems” on page 9-12
  - “Updating CrownNet Software” on page 9-13
-

# Introduction

Network printing difficulties may be caused by one of the five different network components—the printer, the print server, the file server, the workstation, or the network connections between these devices. This chapter contains a list of network printing problems and possible solutions. Besides this manual, you might also need your printer user's guide and any network troubleshooting documentation or software you have.

If you cannot find the answer to your problem in this chapter, call your local QMS vendor or the QMS Customer Response Center (CRC) . See appendix A, "QMS Customer Support," for more information on how to contact us.

## General Problems

### The printer doesn't print.

- If you've just installed an optional QMS CrownNet NIC, be sure you've correctly followed the steps outlined in the setup guide. Also make sure that the Ethernet cable is not connected in a loop and that it is terminated at both ends.
- If your QMS printer has worked on the network before but has recently stopped working, check any changes that have been made to the network, including hardware (workstations, cables, peripherals) and software (applications, utilities, configuration) changes.
- Is the printer plugged in, turned on, and on line?
- Is the printer's IP address correct and unique?
- Does the information on a printer start-up page or status page match the desired printer configuration?

**Configuration changes in the Administration/Communications/xxxxxxx NIC/CrownNet menu (where xxxxxxxx is either Resident or Optional) don't take effect.**

- Turn the printer off and then on again. Some configuration changes take effect only after the printer is turned off and restarted.

**The print quality is poor.**

- Refer to your printer user's guide.

**The media jams.**

- Refer to your printer user's guide.

## **CrownAdmin for DOS Problems**

**CrownAdmin for DOS reports Out of Memory.**

- Check to see if EMM386 or another memory manager is running. Depending on how your system is configured, these can conflict with CrownAdmin.

# **CrownAdmin 3 for Windows, Solaris/SunOS, AIX, and HP-UX Problems**

- » **Note:** *Other troubleshooting information is included in the on-line user's guide. Chapter 4, "CrownAdmin 3" of this manual explains how to access and use the on-line user's guide.*

- **An error message, stating a library file cannot be opened, occurs when CrownAdmin 3 is opened on a UNIX server.**

In the UNIX environment, CrownAdmin 3 is an Xwindows application. To run CrownAdmin 3 from a UNIX workstation, start it from a command prompt within an OpenWindows session.

If you get the error

```
id.so.1: crnadm: fatal: libXext.so.0: can't open  
file: errno=2 Killed
```

when CrownAdmin 3 is started, make sure your library environment has been set to access the OpenWindows libraries. The set environment command belongs to the C-shell.

```
setenv LD_LIBRARY_PATH /usr/openwin/lib
```

- **Problems occur while running CrownAdmin 3 from a UNIX remote workstation.**

Make sure the remote host is in the local host's xhost list and display messages from the remote host are ported to the local host:

- 1 Before logging into the remote host, at the local host type

```
xhost +remote_host_name
```

where *remote\_host\_name* is the name of the the remote host. For example, if the remote host's name is wesley, you would type `xhost +wesley`.

- 2 After logging into the remote host, set the remote environment to port display messages to the local host's IP address by typing

```
setenv DISPLAY local_host's_IP_address:0.0
```

For example, if the local host's IP address is 161.33.131.151, you would type `setenv DISPLAY 161.33.131.151:0.0`

## **EtherTalk Problems**

### **EtherTalk icons are missing from the Control Panel.**

- Reinstall the EtherTalk software that came with your computer's Ethernet board.

### **The printer doesn't appear in the Chooser.**

- Is the printer connected to the network?
- Is the printer plugged in and turned on?
- Is the cable correctly connected to the CrownNet interface port (and, if necessary, correctly terminated)?

### **Network services don't appear in the Chooser.**

- Is the Macintosh connected to the network?
- Is the cable correctly connected to the Macintosh's Ethernet board (and, if necessary, correctly terminated)?
- Are there earlier versions of EtherTalk running on your network?
- Is the Chooser open while you are working in the Control Panel? If you switch the network connection in the Control Panel while the Chooser is open, the network information in the Chooser may not be updated. Close the Chooser and reopen it to see the network information.

## **EtherTalk Problems**

### **You can't print.**

- Have you identified the network, zone, and printer (Macintosh Control Panel and Chooser)?
- Is AppleTalk active (Macintosh Chooser)?
- Is EtherTalk enabled (Administration/Communications/xxxxxxxx NIC/CrownNet/EtherTalk/Mode menu, where xxxxxxxx is either Resident or Optional)?

### **You can't select devices on the printer port.**

- Do you have Chooser version 3.4 or later? This version is necessary to select a device on the printer port.

### **Frequent reinitialization problems occur.**

- Do all Macintosh users on the network have the same version of the Macintosh System file? The EtherTalk Protocol Option works with System 6.0 and later. Each user on the network should be using the same version of the System.
- Do all Macintosh users on the network have the same versions of LaserWriter, LaserPrep, and PrintMonitor files?

To check your LaserWriter, LaserPrep, and PrintMonitor file version numbers, use the following procedure:

- 1 Open your System Folder.**
- 2 Click the LaserWriter file icon once to select it.**
- 3 From the File menu choose Get Info. An Info dialog box appears.**
- 4 The version number is listed near the bottom of the text.**
  - » **Note:** *The version number listed at the top is the System version, not the LaserWriter file version.*
- 5 Close the Get Info dialog box by clicking the close box.**
- 6 Repeat steps 2-5 for the LaserPrep and PrintMonitor file icons.**
- 7 Close the System Folder by clicking the close box.**

# **OS/2 LAN Manager/LAN Server Problems**

**The QMS pipe doesn't appear when you're adding a printer.**

- Did you install the CrownNet Manager for OS/2 correctly?

**The printer's print queue fills up, but nothing prints.**

- Is the printer on line?
- Is the printer correctly configured on the file server?
- Are your printers and print queues configured properly for network printing?
- Is your application set up properly for network printing?
- Did you assign a print queue that is not associated with a printer?

**Some print jobs pass through the print queues without printing.**

- Are the printer's default emulation (Administration/Communications/ESP Default menu) and the interface's default emulation (Administration/Communications/xxxxxxx NIC/Emulation menu, where xxxxxxxx is either Resident or Optional)) set to the same emulation as the print job? They must be set either to ESP or to the same emulation.
- Is the interface enabled (Administration/Communications/xxxxxxx NIC/CrownNet/Common/Emulation menu, where xxxxxxxx is either Resident or Optional))?

**You have a problem selecting and using a print queue.**

- Print queues you select through this software cannot be used by both a local and a network printer.

**Jobs print at the wrong printer.**

- In the Add Queue dialog box, make sure the correct printer is highlighted. Unhighlight any other printers in the list.

**You minimized CrownNet Manager for OS/2 but can't find the minimized icon.**

The location of the minimized icon depends on the version of OS/2 you are using:

- In OS/2 version 1.x the minimized icon is on the desktop.
- In OS/2 version 2.x the minimized icon is in the Minimized Window Viewer.

**The server hangs.**

- Make sure that CrownNet Manager for OS/2 is open only once.

## **NetWare Problems**

**Print screen data doesn't print.**

- Did you use the **capture** command at the DOS prompt before entering an application, include it in your AUTOEXEC.BAT file, or include it in your login script?

To find out if an LPT port is captured, type the following command at the DOS prompt:

```
capture sh↓
```

This command shows you the current status of the LPT ports for the current workstation—in particular, whether they are captured, whether they are set to send data to a network printer or to a file, and how the **capture** options were set.

- Is the interface's default emulation (Administration/Communications/xxxxxxx NIC/Emulation menu, where xxxxxxxx is either Resident or Optional)) set to ESP, HP PCL, or Lineprinter? Print screen data won't print if the emulation is set to HP-GL or Post-Script.



**The printer won't connect to a file server as a NetWare print server.**

- Reset the password for the print server. Refer to "Configuring the NetWare Protocol" in chapter 2, "Printer Configuration," for instructions.

**The application says a print job was sent to the printer, but it doesn't print.**

- Did you either use the **capture** command at the DOS prompt before entering an application, include it in your AUTOEXEC.BAT file, or include it in your login script?

To find out if an LPT port is captured, type the following command at the DOS prompt:

```
capture sh↵
```

This command shows you the current status of the LPT ports—in particular, whether they are captured, whether they are set to send data to a network printer or to a file, and how the **capture** options were set.

- Is the print queue properly defined in the application?

**The printer's print queue fills up, but nothing prints.**

- Is the printer on line?
- Is the printer correctly assigned to a print server?
- Is the printer correctly configured on the network?
- Is your application set up properly for network printing?
- Is the print server allowed to service the queue?
- Are the printer's default emulation (Administration/Communications/ESP Default menu) and the interface's default emulation (Administration/Communications/xxxxxxx NIC/Emulation menu, where xxxxxxxx is either Resident or Optional) set to the same emulation as the print job? They must be set either to ESP or to the same emulation.
- Did you include the no tabs (**nt**) and no formfeeds (**nff**) options in the **capture** command when sending the file?

- Did you assign a print queue that is not connected to a print server?

**Some print jobs pass through the print queues without printing.**

- Is the printer set up to understand the page description language your print job uses (Administration/Communications/xxxxxxx NIC/CrownNet/Common/Emulation menu, where xxxxxxxx is either Resident or Optional)?

**PCONSOLE reports that the remote printer is not connected.**

- On the print server, increase the SPX timeout values (watchdog abort, watchdog verify, ack wait, and/or default retry).

If the print server is a dedicated PC, the NetWare SPX timeout values should be placed in either the SHELL.CFG file or the NET.CFG file. After changing the SHELL.CFG file, restart the dedicated workstation or print server for the changes to take effect, then turn off and on the printer to reconnect the print server. Complete information about the SHELL.CFG and NET.CFG files can be found in the NetWare documentation.

If the print server is an NLM (NetWare Loadable Module) on the file server, use the SPXCONFIG NLM to modify the SPX timeout values. Complete information about the SPXCONFIG NLM is in the NetWare documentation.

**Graphics print in the wrong format.**

- Did you include the notabs (**nt**) and noformfeed (**nff**) options in the **capture** command when sending the file to the printer?
- In the PRINTCON utility, change the File Contents for the print job configuration to Byte Stream.

**A blank page prints at the end of some print jobs.**

- If you're using the NetWare **capture** or **nprint** command with the **formfeed** option and your application automatically enables a form feed at the end of a file, the printer ejects an extra blank page. Use the **capture** or **nprint** command with the **noformfeed** option instead. See the NetWare documentation for more information.

**You have a problem selecting and using a print queue.**

- Print queues you select for the QMS CrownNet interface to service should not also be serviced by a printer connected directly to the file server. If you have a problem selecting and using a print queue in NetWare version 2.x or later, use the following procedure to check whether a print queue is assigned to another printer:

- 1 Log in to the file server as supervisor.**
- 2 Run the NetWare SYSCON utility.**
- 3 From the Available Topics menu, choose Supervisor Options.**
- 4 From the Supervisor Options menu, choose Edit System AUTOEXEC File.**
- 5 In the System AUTOEXEC File entry box, check to see if these lines are present:**

```
printer number add queuename  
spool number to queuename
```

If these lines are not in the AUTOEXEC file (and if the print queue is not assigned to a printer directly attached to the file server), you have not assigned queues to a dedicated printer and may assign any queue(s) to a remote printer.

- » **Note:** *These lines are not necessary to assign a print queue to a printer directly attached to the file server.*

If these lines are in the AUTOEXEC file, *queuename* identifies the queue assigned to a dedicated printer. You cannot assign this queue to a remote printer unless you delete these lines from the AUTOEXEC file.

# TCP/IP Problems

## All UNIX Systems

### The file doesn't print.

- Is the printer correctly configured in the spooling system?
- Is there a printer error? Check the printer's log file on the host for problems with the spooling system, and check the TCP/IP status file for printer status information returned from the printer via TCP/IP.
  - On BSD and SGI spooling systems, the log file is located in `/usr/spool/printername/log`. The status file is located in `/usr/spool/printername/status`. The same status information is available via the **lpq** command.
  - On AIX, HP-UX, and SYS V spooling systems, the log file is in `QMSOft/QDIR/printername/log`. The status file is located in `/usr/spool/printername/status`. The same status information is available via the **lpq** command.

## BSD UNIX Systems

**After you add or change a printer with the QMS `addprt` utility, printing yields unexpected results, such as the job going to the wrong printer or disappearing entirely.**

- Check the `/etc/printcap` file to make sure there is only one entry for the printer. The first entry always takes precedence.

### The job doesn't reach the printer.

- Check the printer's log file for the message

`Hostname printername not found in host table.`

Add the printer to the `/etc/hosts` file.

## **SYS V UNIX Systems**

**The log or status file is not being updated.**

- The file is not writable by **lp**. Perform the following operations on it:

```
chown lp filename↓  
chgrp lp filename↓  
chmod 775 filename↓
```

**The job doesn't reach the printer.**

- Check the printer's log file for the message

```
Hostname printername not found in host table.
```

Add the printer to the `/etc/hosts` file.

# **Updating CrownNet Software**

The QMS CrownNet software is stored in 1 MB of flash ROM, so you can update the software without opening the printer and installing new PROMs. Updated CrownNet software allows you to take advantage of future enhancements.

- » **Note:** *CrownNet software version 1.19 and below cannot be initially updated using this procedure. New version 3.0x or above PROMs must be installed first. (Contact your QMS vendor for QMS-authorized installation, or see "QMS CrownNet 3.0x Upgrade Installation Instructions," which comes with the new CrownNet PROMs.) Once these new PROMs are installed, the CrownNet software may be updated using this procedure in the future. If you're unsure which version of the CrownNet software your printer has installed, print a CrownNet configuration page (the Administration/Communications/xxxxxxx NIC/CrownNet/Common/Config Page menu, where xxxxxxxx is either Resident or Optional).*

The following sections explain the update procedure from several different hosts.

## **System Requirements**

- **If your printer has a hard disk**, there are no special system requirements.
  - **If your printer doesn't have a hard disk**, it must have a recent firmware release (March 1995 or later). If you're unsure about the release date of the firmware, contact QMS. (See appendix A, "QMS Customer Support," for customer contact information.)
- 
- ◆ **Caution:** *Make sure the printer does not receive any print jobs during the upgrade downloading process. It may be necessary to disconnect the printer from the network. If you are using Token Ring make sure that you configure Ring Speed before reconnecting to the network.*
- 
- » **Note:** *A Postscript file contains the upgrade for the CrownNet interface card. It may be used only on the printer/interface card for which it was purchased. It may not be duplicated or copied.*

## **Before You Begin Downloading the Software**

- 1 **Turn on the printer, wait for IDLE to appear in the message window, and then print a CrownNet configuration page (the Administration/Communications/xxxxxxx NIC/CrownNet/Common/Config Page menu, where xxxxxxxx is either Resident or Optional).**
- » **Note:** *Since the downloading procedure replaces the CrownNet software in your printer with the new CrownNet software, all CrownNet configuration settings are replaced with the new factory default settings. The CrownNet configuration page provides a record of all current CrownNet configuration settings, so you can verify them (and reconfigure them, if necessary) after the CrownNet software has been updated.*
- 
- ◆ **Caution:** *Do not reconnect the printer to a Token Ring network until you check the ring speed setting or reconfigure the ring speed to the speed of your network.*
-

- 2 Ensure that the Emulation option for the interface you plan to use to download the CrownNet software is set to ESP or PostScript.**

You'll find the Emulation option in the Administration/Communications/xxxxxxx NIC/ menu (where xxxxxxxx is either Resident or Optional).

- 3 Ensure that the printer is on line and idle.**

## **Downloading the Software**

### **Macintosh Procedure**

- 1 In the Chooser, choose the printer that has the CrownNet software you want to update.**
- 2 Insert the CrownNet upgrade CD-ROM in the Macintosh's CD-ROM drive.**
- 3 Open QMS PS Executive by double-clicking on the PS Exec icon.**

PS Executive is a printer utility shipped with every QMS printer. Refer to your printer documentation, if necessary, for installation instructions.

- 4 From the File menu, choose Print PS File.**
- 5 Click the Option button, make sure all options are disabled, and then click OK.**

- 6 Select the new CrownNet software PostScript XXXXXXXXX.PS file (the name of this file varies), and choose Send.**

A “ReadMe” file on the root directory of the CD-ROM shows you where the file is located on the CD-ROM.

The downloading process takes about 5 minutes.

---

◆ **Caution:** *Once you’ve sent the PostScript file to the printer, **do not** turn the printer off and on again until you’ve waited **at least 5 minutes even if** the message window reads Idle. After the file is downloaded, it takes time for the hardware to be reprogrammed. Interrupting this process will cause unexpected results.*

---

- 7 After at least 5 minutes, if the printer doesn’t reboot automatically, turn it off and then on again.**
  - Printers with a hard disk attached usually must be rebooted manually.
  - Printers without a hard disk reboot automatically.
  - Older printers with a hard disk may have to be turned on and off twice.
- 8 Print another CrownNet configuration page (the Administration/Communications/xxxxxxx NIC/CrownNet/Common/Config Page menu, where xxxxxxxx is either Resident or Optional)), and check the CrownNet software version number to verify successful installation of the upgrade.**
- 9 If necessary, use the CrownNet configuration page you printed before you downloaded the new software to reconfigure the interface to its previous settings.**



## **PC and UNIX Procedure**

### **1 Insert the CrownNet upgrade CD-ROM in the computer's CD-ROM drive.**

» **Note:** *On UNIX systems you may have to mount the CD drive before using the CD-ROM. Go to the root directory and make a directory for the CD-ROM. Mount the CD-ROM file system by typing one of the following commands:*

- For AIX, type `mount -o ro -v cdrfs device_filename /cdrom`
- For HP-UX, type `mount -t cdfs device_filename /cdrom`
- For SunOS, type `mount -r -t hsfs device_filename /cdrom`

### **2 Download the new CrownNet software PostScript XXXXXXXX.PS file (the name of the file varies) to the printer any way you would normally send a PostScript file. A “ReadMe” file on the root directory of the CD-ROM will show you where the file is located on the CD-ROM.**

For example, you might use QMS CrownAdmin 3, QMS PS Executive, **copy /b**, or **fstprn** from a PC, or **qpr** or **put** from a UNIX system. (PS Executive is a printer utility shipped with every QMS printer. Refer to your printer documentation, if necessary, for installation instructions.)

The downloading process takes at least 5 minutes.

---

◆ **Caution:** *Once you've sent the PostScript file to the printer, **do not** turn the printer off and on again until you've waited **at least 5 minutes even if** the message window reads **Idle**. After the file is downloaded, it takes time for the hardware to be reprogrammed. Interrupting this process will cause unexpected results.*

---

## **Updating CrownNet Software**

- 3 After at least 5 minutes, if the printer doesn't reboot automatically, turn it off and then on again.**
  - Printers with a hard disk attached reboot automatically.
  - Printers without a hard disk attached must be rebooted manually.
  - Older printers with a hard disk may have to be turned on and off twice.
- 4 Print another CrownNet configuration page (the Administration/Communications/xxxxxxx NIC/CrownNet/Common/Config Page menu, where xxxxxxxx is either Resident or Optional), and check the CrownNet software version number to verify successful installation of the upgrade.**
- 5 If necessary, use the CrownNet configuration page you printed before you downloaded the new software to reconfigure the interface to its previous settings.**



# A

---

## **QMS Customer Support**

---

### **In This Chapter . . .**

- Sources of customer support
- QMS world-wide offices



# Sources of Support

Several sources of help and information are available, depending on the type of help you need:

## **Your QMS Vendor**

Your local vendor (the one from whom you bought the printer) may be best equipped to help you. Your vendor has specially trained service technicians available to answer questions, and the equipment to analyze your printer problems.

## **Your Application Vendor**

Often, "printing" problems have more to do with the application being used than with the printer. In this case, the application manufacturer is the best source of help.

## **Q-FAX**

Q-FAX, a QMS information retrieval service, provides application notes, technical support notes on common printing problems, and information about printer specifications, options, accessories, consumables, and prices.

In the United States and Canada, call (800) 633-7213 to reach Q-FAX. In all other countries, call (334) 633-3850. Have your fax number handy when you call (or place the call from your fax machine's handset).

You can choose to have either a directory (a list of currently available documents) or a specific document sent to you. The first time you call, request the directory (press 2 on your phone or fax keypad when prompted). Then call back to request specific documents. You can order up to three documents per call.

## **CompuServe**

Through CompuServe, you ask general (non-technical) questions, share information with other users, and access printing information and programs. When you use CompuServe, type `go qmsprint` to go directly to the forum where QMS is located. The QMS library section contains application notes, printer drivers, utilities, technical information, and announcement files.

## **Internet**

The QMS server provides access to technical reports, new product announcements, a trade show schedule, and other general information about QMS.

If you have access to the World Wide Web, you can view the QMS home page at <http://www.qms.com/>. The QMS ftp resource is <ftp.qms.com>.

## **QMS Customer Response Center (CRC)**

You can contact the QMS Customer Response Center (CRC) in three different ways:

- **Telephone**—You can call the CRC at (334) 633-4500 (US) Monday–Friday, 7:00 am–6:00 pm, Central Time.
- » **Note:** *If you call for assistance, have the following information ready so our technicians can help you more quickly:*
  - ☑ Your phone number, fax number, and shipping address
  - ☑ A description of the problem
  - ☑ The printer model
  - ☑ The type of host computer you're using
  - ☑ The type and version of operating system you're using
  - ☑ The interface you're using, and, if serial, the protocol (for example, XON/XOFF)
  - ☑ The application and version you're using
  - ☑ The emulation you're using
  - ☑ Your printer firmware version (listed on the status/start-up pages)
- **Fax**—You can fax questions to the CRC at (334) 633-3716 (US). Provide the same information as listed above, and indicate whether you would like a faxed or a phoned reply.
- **Internet**—If you have access to the World Wide Web, you can access the CRC through the QMS home page at <http://www.qms.com/>

# **QMS World-wide Offices**

---

## **QMS United States and Latin America**

---

### **General Contact**

1 (334) 633-4300

Fax 1 (334) 633-4866

Email [info@qms.com](mailto:info@qms.com)

Internet <http://www.qms.com>

Information on QMS products, supplies, and accessories, and on the authorized QMS remarketer or service provider nearest you

1 (800) 523-2696

### **Customer Response Center (CRC)**

Technical Assistance

1 (334) 633-4500

7:00 am–6:00 pm Central Time

Fax 1 (334) 633-3716

Internet <http://www.qms.com>

### **Latin America Fax**

1 (334) 639-3347

### **National Service**

Service Information, Installation, and Maintenance Pricing

1 (800) 762-8894

On-Site Service and Depot Repair Information

1 (800) 858-1597

7:00 am–7:00 pm Central Time

Spare Parts Ordering and Information

1 (334) 633-4300 x2530

8:00 am–5:00 pm Central Time

---

## **QMS Canada**

---

### **General Contact**

1 (514) 340-0646

Fax 1 (514) 340-0401

Supplies and Accessories

1 (800) 268-0343 x223

### **National Service**

On-Site Service and Depot Repair Information

1 (800) 268-4969

8:30 am–7:00 pm Eastern Time

Spare Parts Ordering and Information

1 (905) 206-9234 x238

8:30 am–5:00 pm Eastern Time

---

## **QMS in Japan**

---

**General Contact**

(+81)-3 3779-9600

Fax (+81)-3 3779-9650

Internet <http://www.qmsj.co.jp>

---

## **QMS in Latin America**

---

**General Contact**

Cra 43 DD#8-42

Oficina 201

Medellin, Colombia

(+57) (4) 312 13 70

Fax (+57) (4) 268 92 97

---

## **QMS EMEA**

---

**QMS Australia**

Anitech

Sydney Business & Tech. Centre

52/2 Railway Parade

2141 Lidcombe NSW

Australia

(+61) 2-9901 3235

Fax (+61) 2-9901 3273

---

**QMS Benelux**

Planetenbaan 60 'Corner Plaza'

3606 AK Maarsse

The Netherlands

**Belgium, Netherlands, and all  
unlisted countries**

(+31) 346-551333

Fax (+31) 346-550170

Internet <http://www.qms.nl>

---

**QMS France**

Vélizy Plus

1 Bis, Rue du Petit Clamart

78142 Vélizy Cedex

France

(+33) 1-410 79 393

Fax (+33) 1-408 30 110

---

**QMS GmbH**

Gustav Heinemann Ring 212

D-81739 Munich

Germany

**Germany and  
Austria**

(+49) 89 63 02 67 0

Fax (+49) 89 63 02 67 67

---



**QMS World-  
wide Offices**

<b>QMS Italy</b>	Via della Repubblica 56 43100 Parma Italy (+39) 52-1231 998 Fax (+39) 52-1232 902
<b>QMS Nordic</b> <b>Sweden, Finland, Norway, and Denmark</b>	Arenavägen 41, 6th floor 121 77 Johanneshov Sweden (+46) 8-600 01 30 Fax (+46) 8-600 01 33
<b>QMS South Africa</b>	Saskay House Unit 24 Sunninghill Business Park Peltier Road, Sunninghill, Johannesburg Republic of South Africa (+27) 11-807 6957 Fax (+27) 11-807 6960
<b>QMS UK</b> <b>United Kingdom and Ireland</b>	Old Bridge House, The Hythe Staines, Middlesex TW18 3JF United Kingdom (+44) 1784-442255 Fax (+44) 1784-461641





# B

---

## Technical Specifications

---

### In This Appendix . . .

- “CrownNet Specifications” on page B-2
  - “EtherTalk Specifications” on page B-4
  - “OS/2 LAN Manager/LAN Server Specifications” on page B-5
  - “NetWare Specifications” on page B-6
  - “TCP/IP Specifications” on page B-8
-

# **CrownNet Specifications**

## **Features**

- ETRAX microprocessor operating at 32 MHz
- 1-2 MB Flash ROM
- 256 KB SRAM
- 2 MB DRAM
- Diagnostics
- Hardware address—configurable
- Job cancellation support
- Job ID handling
- QMS CrownAdmin 3 for AIX, HP-UX, Solaris, SunOS, Macintosh, OS/2, and Windows support
- QMS CrownAdmin for DOS
- QMS CrownNet Manager for OS/2 support
- QMS CrownNet Print Utility for Windows 98 support
- QMS Network Print Monitor for Windows 98
- QMS Network Print Monitor for Windows NT
- QMS Remote Console support
- Start-up page, printer—CrownNet entries added
- Status page, printer—CrownNet entries added
- Printer-based accounting
- Printer resident web pages

## **Networks and Protocols**

### **Ethernet**

- EtherTalk (Phase 2)
- OS/2 LAN Manager/LAN Server/Microsoft (NetBIOS/NetBEUI)
- NetWare (IPX/SPX)
- TCP/IP (including AIX, BSD, HP-UX, and SYS V systems)

### **Token-Ring**

- OS/2 LAN Manager/LAN Server (NetBIOS/NetBEUI)
- NetWare (IPX/SPX)
- TCP/IP (including AIX, BSD, HP-UX, and SYS V systems)

## **Network Attachments**

- 10Base2 (thin-wire) Ethernet via BNC connector
- 10Base 5 (thick-wire) Ethernet via AUI connector
- 10BaseT/100BaseT (twisted-pair) Ethernet via RJ45 connector
- Shielded twisted-pair Token-Ring via IBM Type 1-compliant cable
- Unshielded twisted-pair Token-Ring via Type 3-compliant cable

## **Network Speed—Token-Ring**

- 4 Mbit/sec
- 16 Mbit/sec

# **EtherTalk Specifications**

## **Connections**

- Conventional—1
- PAP (Printer Access Protocol) spooling—4

## **Features**

- ADSC 2.0 (Adobe Document Structure Convention) support
- Chooser support
- QMS CrownAdmin 3 for Macintosh support
- Font list—dynamic
- LaserWriter version 6, 7, and 8 support
- Printer naming utility
- Reverse channel
- QMS Remote Console support
- Zone names—Configurable, full compliance with AppleTalk zone naming conventions

## **Protocols**

- AARP (AppleTalk Address Resolution Protocol) support
- ATP (AppleTalk Transaction Protocol) support
- NBP (Name Binding Protocol) support
- PAP (Printer Access Protocol) spooling support
- RTMP (Routing Table Maintenance Protocol) support
- ZIP (Zone Information Protocol)

# **OS/2 LAN Manager/LAN Server Specifications**

## **Connections**

- Multiple queues supported
- Multiple servers supported

## **OS/2 Features**

- QMS CrownNet Manager for OS/2 support
- QMS CrownAdmin 3 for OS/2 support
- Help—OS/2 style, context sensitive
- IBM LAN Server Version 1.3 and above running on OS/2 1.2 and above
- Job completion notification
- Job error detection, reporting, and logging
- Microsoft LAN Manager Version 2.0c and above running on OS/2 1.2 and above
- NPS Manager support
- OS/2 Spool support
- Pipes support
- Printer chooser utility
- Program/Print Manager support
- QMS Remote Console support through QMS CrownAdmin 3
- Security—Multiple levels
- Separator page support

# **Microsoft Windows Network Features**

- QMS CrownNet Print Utility for Windows support
- QMS CrownAdmin 3 for Windows support
- Help—Windows style, context-sensitive
- Microsoft Windows 3.1 with LAN Server/LAN Manager Workstation Service
- Windows for Workgroups 3.11, Windows NT 3.5 and greater, or Windows 95 with Microsoft Windows Network (NetBIOS/NetBEUI)
- QMS Network Print Monitor for Windows 95 and Windows NT
- Job completion notification
- Job error detection and reporting
- Microsoft Windows Print Manager and Control Panel support

## **Protocols**

- NetBEUI (NetBIOS Extended User Interface) support
- NetBIOS support
- TCP/IP support

# **NetWare Specifications**

## **Bindery Connections**

- Print server
  - File servers—16 simultaneous
  - Print queues—64



## **NDS Connections**

- Print server
  - File servers—16 simultaneous
  - Print queues—64
- RPrinter and NPrinter—total of 8 simultaneous in any combination
- PServer and RPrinter/NPrinter active simultaneously

## **Features**

- Novell YES certified
- Copies—NetWare **count** support
- QMS CrownAdmin for DOS and CrownAdmin 3 for AIX, HP-UX, Macintosh, OS/2, Solaris, SunOS, and Windows support
- Dynamic timeouts
- Encrypted password support
- File server discovery on reboot
- Frame types—Automatic sensing of IEEE 802.2, IEEE 802.3, SNAP, IEEE 802.5 and 802.5 SNAP for Token-Ring, and Ethernet II frame types
- Job check interval—configurable
- NCP burst mode support
- Job completion notification—NetWare **notify** support
- NetWare banner page support
- NetWare 2.2, 3.11, 3.12, 4.x, 5.x, NDS, NDPS Legacy Printers and portable NetWare compatibility
- QMS header page support
- QMS Remote Console support
- Routing of outgoing data
- Sideband printing

## **Protocols**

- IPX (Inter Network Packet Exchange)
- NCP (NetWare Core Protocols)
- RIP (Routing Information Protocol)
- SAP (Service Advertising Protocol)
- SPX (Sequential Packet Exchange)
- NDS (Novell Directory Services)

# **TCP/IP Specifications**

## **Connections**

- FTP (File Transfer Protocol)—4
- LPD (Line Printer Daemon)—4
- Telnet—8
- Transport1—8

## **Features**

- Accounting support
- QMS CrownAdmin for DOS and CrownAdmin 3 for AIX, HP-UX, Solaris, SunOS, Macintosh, OS/2, and Windows support
- Gateway support
- HOST.EQ support
- IP packet reassembly
- Password protection via PASSWORD.FTP file
- Printer status via **lpq** (Line Printer Queue)

- **qef** support
- Reverse channel support
- SNMP support
- STATUS1 (QMS) support
- Subnet mask support
- TCP (Transmission Control Protocol) windowing
- Telnet options support
- TRANSPORT1 (QMS) support
- QMS UNIX Host Software support
- Requirements for Internet Hosts—Communication Layers
- Requirements for Internet Hosts—Application and Support
- Wollongong's Pathworks compatibility

## **FTP**

- Password protection via PASSWORD.FTP file
- Simultaneous **gets**—1
- Simultaneous **logins**—4
- Simultaneous **mputs**—1
- Simultaneous **puts**—1
- Timeouts—Fixed

## **Protocols**

- ARP (Address Resolution Protocol)
- BOOTP (Boot Protocol)
- ECHO
- FTP (File Transfer Protocol)
- ICMP (Internet Control Message Protocol)

## **TCP/IP Specifications**

- IP (Internet Protocol)
- RARP (Reverse Address Resolution Protocol)
- SNMP (Simple Network Monitoring Protocol)
- TCP (Transmission Control Protocol)
- Telnet
- UDP (User Datagram Protocol)

## **SNMP**

- MIB II compliant
- QMS MIB
- Traps—5 reports to up to 5 NMSs

## **Telnet**

- Connection timeout—None
- QMS Remote Console support
- Simultaneous connections—8
- Time mark



# C

---

## **SNMP and TCP/IP Concepts**

---

### **In This Appendix . . .**

- “SNMP” on page C-2
- “TCP/IP” on page C-5
- “TCP/IP Accounting and Reverse Channel” on page C-8

---

# Introduction

This chapter first provides a brief overview of SNMP, and then it discusses several TCP/IP concepts, including subnetting and subnet masks, internet routing and gateways, and Class A, B, and C, Internet addresses. Terms are defined in the glossary.

## SNMP

A manageable network is composed of one or more Network Management Stations (NMSs) and a group of agents. The NMSs are systems responsible for managing the network; an agent is software or a networked device that forwards information to the NMSs. With the CrownNet interface daughterboard installed, your printer performs the functions of an agent.

SNMP (Simple Network Management Protocol), part of the suite of Internet protocols, is a standard message-handling protocol used to monitor internet networks and gateways. SNMP allows each NMS to access management information (such as job, bin, interface, emulation) on an agent and, in some instances, to change that information. Each request by an NMS for information on an agent is accompanied by a community name, and a password that allows the manager access to that information. All of the management information available on an agent is referred to as the Management Information Base (MIB).

The QMS agent is RFC 1157 compliant. Therefore, it supplies information according to the MIB-II definition.

## Traps

While an NMS usually explicitly requests information from an agent, agents can also send information to a manager without an explicit request. This is called trapping. Traps are unsolicited, asynchronous messages from agents to NMSs. They alert the NMS to changes that

occur on the agent's device and about which the NMS should know (for example, a media jam).

Since these messages are generated by the agent, it is mandatory that the addresses of these NMSs be defined so the agent will know where to send the information. Up to five NMSs can be configured through the SNMP Config submenu. When a printer error occurs, the agent sends the information to each of the defined management stations.

## Communities and Community Names

A community is a group of agents managed by an NMS. A community name is a password that enables SNMP access to the agent.

A community name is associated with an NMS address. For the NMS to gain access to the agent, the correct community name must be supplied when connecting. Each community name can be assigned different privileges. Community names are identified through the printer's SNMP Config submenu.

## QMS-Specific Management Information Base (MIB)

The Management Information Base (MIB) is the information on an agent that can be accessed via SNMP. It can also be imported into other printer management systems.

The following groups are defined in the QMS MIB. Consult the QMS MIB for object declarations within these groups.

Group	Notes
qmsInc	This is the top level group
qmsUIH	This is the second level. All of the following groups are the third level under this one.
qmsSystem	Contains information on the printer system such as, printer model, printer name.
qmsMemory	Memory client configuration parameters.

Group	Notes
qmsloCtl	Front end parameters.
qmsHTTP	Printer web page parameters.
qmsloTimeOuts	Printer timeout parameters.
qmsloPages	Special page parameters.
qmsSerial	Optional serial interface parameters.
qmsParallel	Parallel interface parameters.
qmsEngine	Print engine parameters. Varies depending on the model of printer.
qmsAccounting	Printer-based accounting parameters.
qmsScanner	Optional scanner parameters.
qmsPS	Printer's PostScript parameters.
qmsHPGL	HPGL emulation parameters.
qmsHPPCL	HPPCL emulation parameters.
qmsDECLN03	Optional DEC LN03 emulation parameters.
qmsQUIC2	Optional QUIC2 emulation parameters.
qmsLinePrinter	Optional Lineprinter emulation parameters.
qmsTIFF	Optional TIFF emulation parameters.
qmsCALS	Optional CALS emulation parameters.
qmsCGM	Optional CGM emulation parameters.
qmsRel	This is a second level. The following groups are under this level.
qmsPrinter	Printer configuration parameters.
qmsIF	CrownNet configuration parameters.
qmsConfig	Configuration menu parameters

## Changing Printer Configuration via SNMP

You can use SNMP, rather than the printer's control panel, CrownAdmin 3, or Remote Console, to change the CrownNet interface's configuration.



- » **Note:** *Some NMSs require settings to be identified as integers rather than as strings. If this is necessary, check the MIB for the integer corresponding to the desired setting.*

### **Example**

This example shows how to change the printer's default EtherTalk connection from Both to Spooling.

#### **1 Change the value.**

Set

```
enterprises.qmsInc.qmsRel.qmsIF.qmsIFSetup.qmsIFApple.qmsIFAppleTalk-  
Menu.atkConnType
```

to Spooling.

#### **2 Make the change permanent (save it to NVRAM).**

Set

```
enterprises.qmsInc.qmsRel.qmsIF.qmsIFAdmin.qmsIFAdminMenu.qmsIFAdmin-  
ConfigStatus
```

to configSaveRequest.

#### **3 Reset the printer.**

Set

```
enterprises.qmsInc.qmsRel.qmsIF.qmsIFAdmin.qmsIFAdminMenu.qmsIFAdmin-  
UnitStatus
```

to hardReset.

## **TCP/IP**

### **Subnetting**

One of the ways a single network address can span multiple physical networks is through subnetting, which divides the host part of an internet address into a physical network part and a host part. In other

words, it creates a hierarchical address, which identifies a subnet within an internet and then a host within a subnet.

The main advantage of subnetting is that it accommodates large growth since a given gateway does not need to know as much detail about distant destinations as it does about local ones.

### Subnet Masks

- » **Note:** *If the subnet mask remains set to the default (000.000.000.000) in the Administration/Communications/Network/TCP/IP/Subnet Mask menu, the CrownNet interface provides automatic sensing of gateways. If you identify a subnet mask, this automatic sensing is disabled.*

If a subnet address is used to identify a host, a corresponding 32-bit subnet mask must also be designated. Like internet and subnet addresses, the subnet mask is written in binary form for the network. Bits are set to 1 if the network treats the corresponding bit in the internet address as part of the network address, and to 0 if it treats the bit as part of the host identifier. For example, the binary subnet mask

11111111 11111111 11111111 00000000

specifies that the first three groups of eight digits in the internet address identify the network and subnet and that the fourth group identifies the host on that subnet. However, these numbers are more commonly written in decimal form. For example, the binary subnet mask above would be written in decimal form as

255.255.255.0

### Internet Routing

Once the internet address, subnet addresses, and subnet masks are in place, information can be sent, or routed, to any destination in the internet. Both hosts and gateways participate in the routing process.

If information is sent between two devices on a single physical network, or subnet, no gateways are involved. The sending device encapsulates the datagram in a physical frame, binds the destination

internet address to a physical hardware address, and sends the resulting frame directly to the destination.

If the information is sent between two devices on two different physical networks, however, the internet gateways form a cooperative, interconnected structure. Datagrams pass from gateway to gateway until they reach a gateway that can deliver them directly to a device on that physical network.

## Class A, B, and C Internet Addresses

TCP/IP defines a means for the network administrator to configure the network that best suits the network environment at a site. One method is to define the 32-bit TCP/IP network address in terms of the number of networks and the number of hosts at the site. The network address is partitioned into a network part and a host part.

There are 3 common partitions—Class A, Class B, and Class C. The classification is done by the highest order bits. For example, a 0 in the highest order bit of the 32-bit address indicates that the address is Class A. Thus, the next 7 bits constitute the network address, and the last 24 bits form the host address. The high order bits also constitute the network mask for the Class A address.

The following table identifies the differences between Class A, B, and C addresses.

Class	Uses	Highest Order Bits (Binary)	Network Address Size	Host Address Size	Network Mask (Hex)
A	Sites with few networks and many hosts	0	7 bits	24 bits	0xFF000000
B	Sites with some networks and some hosts	10	14 bits	16 bits	0xFFFF0000
C	Sites with many networks and few hosts	110	21 bits	8 bits	0xFFFFF000

# TCP/IP Accounting and Reverse Channel

## The qef Command

The QMS **qef** command allows you to manage TCP/IP accounting and reverse channel information.

- » **Note:** *TCP/IP accounting/reverse channel is available only on some printers. The QMS CrownNet interface determines if the motherboard supports this feature.*

## Syntax

To use the **qef** command, type

```
qef options↓
```

where *options* is replaced by the appropriate options from the following table.

## Options

The following options are available for the QMS **qef** command.

<b>-a</b>	Enables an “alternative” format for the status messages appearing in the log files. This format consists of a string of numbers that identify the date, as well as a more standardized format for the status field and printer error messages. Selecting this option automatically enables the <b>-r</b> option.
<b>-b revchanjob</b>	Indicates the filename to be used for storing reverse channel information for the most recent job. This file is overwritten on a job-by-job basis. <i>revchanjob</i> may be the same name as <i>jobfile</i> , allowing you to keep the accounting job information and the reverse channel job information in the same file.  Omission of this flag and argument indicates that the <i>revchanjob</i> file will not be built. If both this flag and the <b>-B</b> flag are omitted, no reverse channel information is logged.

<b>-B <i>revchanlog</i></b>	<p>Indicates the filename used for storing the reverse channel log. This file is kept from job to job and contains the cumulative information from each <i>revchanjob</i> file. This file is not purged by the UNIX utilities. It is the user's responsibility to keep this file from growing too large. <i>revchanlog</i> may be the same name as <i>logfile</i>, allowing you to keep the accounting log information and the reverse channel log information in the same file.</p> <p>Omission of this flag and argument indicates that the <i>revchanlog</i> file will not be built. If both this flag and the -b flag are omitted, no reverse channel information is logged.</p>
<b>-f <i>filename</i></b>	<p>Indicates the name of the file to be transferred.</p> <p>Omission of this flag indicates that standard input will be used. Information is logged.</p>
<b>-g <i>time</i></b>	<p>Gives the time (in seconds) between each status request. The range is from 0 to 60. Values greater than 60 are truncated to 60, and values less than 0 are converted to 0.</p> <p>If this argument is omitted, the default value (5 seconds) is used.</p>
<b>-h <i>host</i></b>	<p>Indicates the host name of the printer which later will be transferred. This should match the entry in the <i>/etc/hosts</i> file.</p>
<b>-j <i>jobfile</i></b>	<p>Indicates the job file to be generated. This file contains the cumulative printer status information over an entire job. This file is overwritten on a job-by-job basis.</p> <p>Omission of this flag and argument indicates that the job file will not be built.</p>
<b>-l <i>logfile</i></b>	<p>Indicates the log file to be generated. This file is kept from job to job, and contains the cumulative information that was contained within each job file. This file is not purged by the UNIX utilities. It is the user's responsibility to keep this file from growing too large.</p> <p>Omission of this flag and argument indicates that the job file will not be built.</p>

## TCP/IP Accounting and Reverse Channel

<b>-o</b>	<p>Turns off accounting and reverse channel by setting <b>qef</b> back to "original" mode. Jobs executed by <b>qef</b> in original mode do have their status or reverse channel information written to the job and log files. (The non-accounting <b>qef</b> status messages (such as <code>Job transmission completed</code> and <code>Spooler terminated</code> communication continue to be written to the regular [non-accounting] status and log files.)</p> <p>If both accounting and reverse channel are disabled during an <b>addprt</b> session, this option is set.</p>
<b>-p port#</b>	<p>Allows you to select a port number (other than a default of 35) for communication between the CrownNet interface utilities and the CrownNet interface.</p>
<b>-r</b>	<p>Causes the "time" field for each status reply to be displayed in a real-time (time of day) format. The real-time value is obtained from the host.</p> <p>If <b>-r</b> is omitted, the time field is displayed as a "delta" time (the elapsed number of seconds, minutes, hours from the beginning of the job up to the time of the current status reply). The delta time format is probably more useful in determining total printing time for a given job.</p>
<b>s statfile</b>	<p>Indicates the status file to be generated. This file contains only one line of information and is overwritten by each status change in a job. The main purpose of this file is to allow users to display printer status using the UNIX <b>lpq</b> utility.</p>
<b>-v</b>	<p>Indicates that verbose mode is to be used. Without this flag, only the last accounting status entry is placed in both the job and log files. (This is used to limit the size of these files while still reporting necessary information regarding accounting.)</p> <p>If this flag is supplied, status information that is different from the previous status information is stored in the job and log files.</p>

## Accounting Information Format

The formatting of the information sent to each file is done by the UNIX Host Software. This allows you to customize the output. The status-

gathering software does not accommodate foreign languages other than to reproduce motherboard-generated foreign language printer error strings. Two formats are supplied: standard and alternative.

**Standard Format**

The standard format is

%%[status: *s*; pagecount: *p*; interface: *i.hostname*; user: *u*; title: *T*; time: *t*]%%

The following list provides more information about these variables:

<b>status: <i>s</i></b>	Printer status. Valid printer status messages are Idle Busy Interpreting Printing Rasterizing Spooling Terminating
<b>pagecount: <i>p</i></b>	The number of the page currently being processed. The last reported value (when the printer is idle) is the total number of pages for the job being printed.
<b>interface: <i>i</i></b>	The interface being used.
<b><i>hostname</i></b>	The name of the printer to which the job was sent.
<b>user: <i>u</i></b>	The user sending the job (as indicated by the DOC %% <b>For</b> command). If the %% <b>For</b> command is missing, <i>u</i> is replaced by "Unknown."
<b>title: <i>T</i></b>	The title of the job as given (as indicated by the DOC %% <b>Title</b> command. If the %% <b>Title</b> command is missing, <i>T</i> is replaced by "Unknown."
<b>time: <i>t</i></b>	The real time as determined by the host's clock or the delta time as determined by the CrownNet interface.

**Example**—This is an example of standard format output:

```
%%[Status: printing; pagecount: 12; interface:Ethernet:q33;
user: fred; title: accounting.doc; time: 01:02:03]%%
```

**Errors**—Errors are reported as

**TCP/IP  
Accounting and  
Reverse  
Channel**

%%[PrinterError: string]%%

where *string* is a description of the problem. The errors vary according to the printer model. However, a typical example is

%%[PrinterError: ADJUST INPUTBIN]%%

Since it is possible that the exact same status be returned each time the status request is made, duplicate messages are discarded.

**Alternative Format**

This alternative format allows you to create a utility to scan the log files automatically and to assemble the data. The format of the command is

ttttttttf%%[status: s; source: i:hostname; pagecount: p; user: u; title: T]%%

The following list provides more information about these variables:

<b>ttttttttt</b>	A string of numbers indicating real time. For example, 0215155656 indicates "Mon Feb 15 15:56:56 CST 1996."
<b>status: s</b>	Printer status. Valid printer status messages are  idle busy processing rasterizing spooling
<b>source: i</b>	The interface being used.
<b>hostname</b>	The name of the printer to which the job was sent.
<b>pagecount: p</b>	The number of the page currently being processed. The last reported value (when the printer is idle) is the total number of pages for the job being printed.
<b>user: u</b>	The user sending the job (as indicated in the DOC %%For command). If the %%For command is missing, <i>u</i> is replaced by "Unknown."
<b>title: T</b>	The title of the job (as indicated by the DOC %%Title command). If the %%Title command is missing, <i>T</i> is replaced by "Unknown."



**Example**—This is an example of the alternative format output:

```
0215155656%%[Status: busy; source:Ethernet:q33; page-  
count: 12; user: fred; title: accounting.doc]%%
```

**Errors**—Errors are reported in the format

```
tttttttt%%[PrinterError: string]%%
```

where *tttttttt* is a string of numbers indicating real-time, and *string* is a description of the engine problem. This information varies according to printer model. However, an attempt is made to search for key words in the error string returned by the printer to provide a subset of basic error messages that is identical for several slightly different error strings returned by the printer (for example, paper jam, paper out). Again, this is done to facilitate easy automatic parsing of the log file. (As mentioned above, no support is provided for foreign languages, and no special subset of error messages is generated within the log files if the printer's message window is set to a language other than English.) For example, a paper feed jam is reported as

```
0215155656%%[PrinterError:paper entry misfeed]%%
```

and any other type of paper jam as

```
0215155656%%[PrinterError:paper jam]%%
```

Since it is possible that the same status is returned each time that the status request is made, duplicate messages are discarded.

## **Reverse Channel Information Format**

The reverse channel information does not require formatting by the host software; it is stored in the log file in the form returned by the PDL interpreter.

For example, a PostScript error might be returned as

```
%%[ Error: undefined; OffendingCommand: junk]%%
```

The format of other information is entirely dependent on the PDL code used to generate it. For example, an informative string containing PostScript pagecount information might be returned as

```
%%[ status: starting job; pagecount: xxxx;otherstring ]%%
```

## TCP/IP Accounting and Reverse Channel

in response to the following PostScript code:

```
(%%[ status: starting job; pagecount: ) print
statusdict /pagecount get exec =print
(; otherstring ]%%) print
```

or

```
%%[status: finished job; pagecount: xxxx;]%%
```

in response to the following PostScript code:

```
(%%[ status: finished job; pagecount: ) print
statusdict /pagecount get exec =print
( ]%%) print
```

where xxxx represents the printer's page count since initial powerup with the current code revision (in other words, it is identical to the "Faces Printed" value from the start-up page).

## Spooling

Since **qef** requests accounting status from the printer until the job is completely finished and the printer is idle, spooling is effectively eliminated. This reduces printer speed.

Reverse channel also requires spooling to be disabled.

## Accounting Packet Format

The accounting status information is transferred from the printer to the host in UDP packets which contain the following fields:

Field	Data Type	Description
status	Integer	Represents the status of the job (see the following table).
page	Integer	Indicates the current logical page count.
interface	Integer	Indicates the current interface (where decimal 16 is the optional I/O).
sheet count	Integer	Indicates the current physical page count.
job id	Integer	Represents the job I.D. on the printer.

byte size	Integer	Gives the byte count of the job (not currently implemented).
emulation	Integer	Returns the emulation selected for the job (not currently implemented).
name	String	Identifies the owner of the job.
title	String	Identifies the title of the job.

Each value is separated by a linefeed within the ASCII string of the UDP packet. Some information returned is not recorded to the status file.

The following table maps text descriptions to the integer reported in the UDP packet. The status can be found by masking the status returned with the following hex keys. More than one of these conditions can occur at one time on a single job.

<b>Status</b>	<b>Hex key</b>
Waiting	0x20
Terminating	0x10
Printing	0x8
Rasterizing	0x4
Interpreting	0x2
Spooling	0x1

## **Reverse Channel Packet Format**

The reverse channel information is then transferred from the printer to the host in UDP packets, each consisting of a string of characters. This string contains the reverse channel information exactly as it was generated by the PDL interpreter.





# D

---

## CrownNet Menus

---

### **In This Appendix . . .**

- “Entering the CrownNet Menu” on page D-2
  - “Common Menu” on page D-3
  - “EtherTalk Menu” on page D-4
  - “Lan Manager Menu” on page D-5
  - “NetWare Menu” on page D-6
  - “TCP/IP Menu” on page D-7
-

# Introduction

Use the following menu flowcharts to help find your way around the CrownNet menu structure.

- » **Note:** *The structure of these flowcharts may vary slightly with older versions of CrownNet. See your printer documentation for higher level menus.*

## Entering the CrownNet Menu

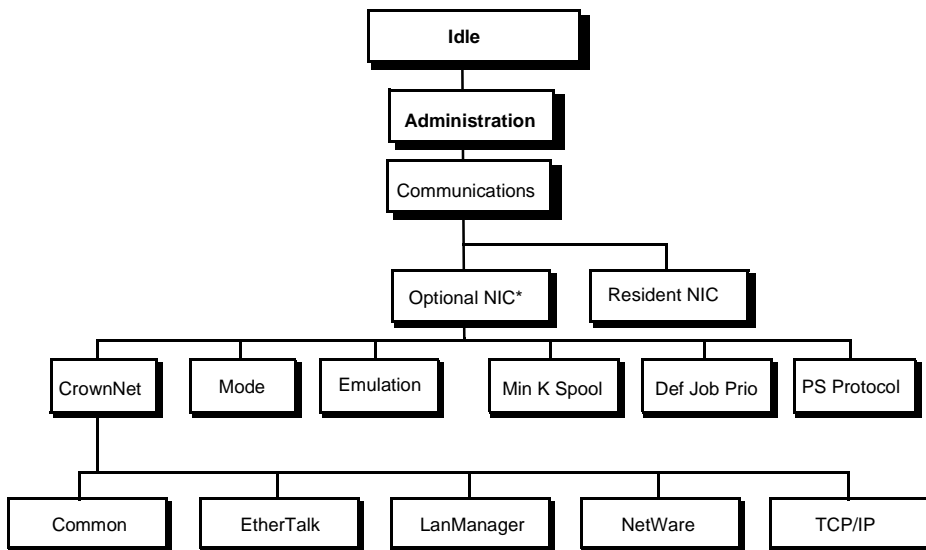

*\*Some printers may not have an Optional NIC interface menu.*

## Common Menu

This menu gives you choices common to all of the CrownNet communications interfaces.

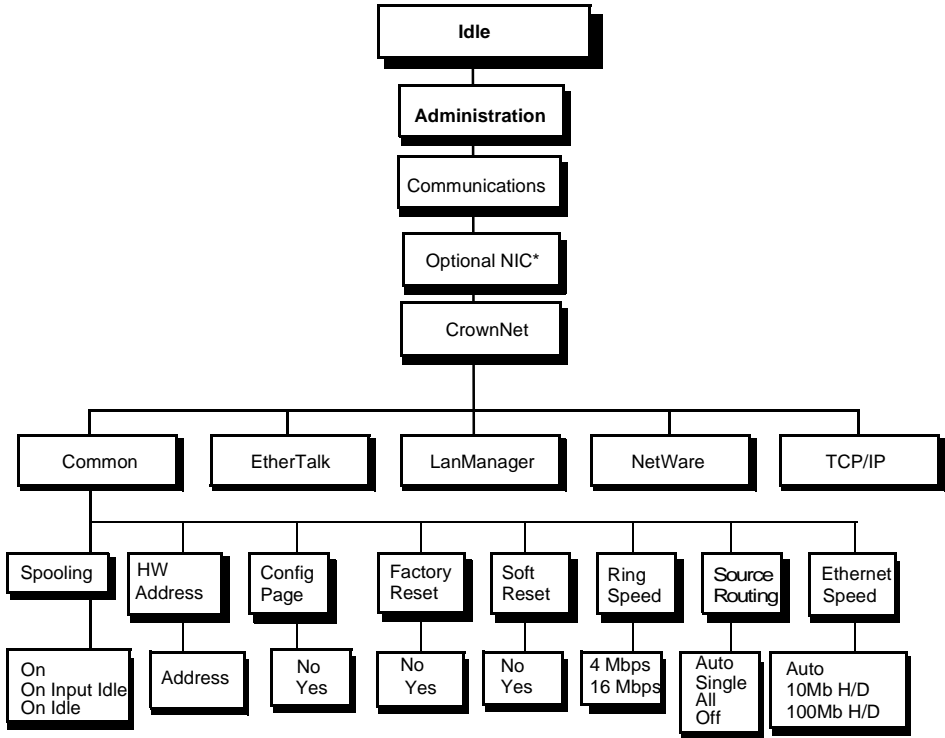

*\*Some printers may not have an Optional NIC interface menu.*

## **EtherTalk Menu**

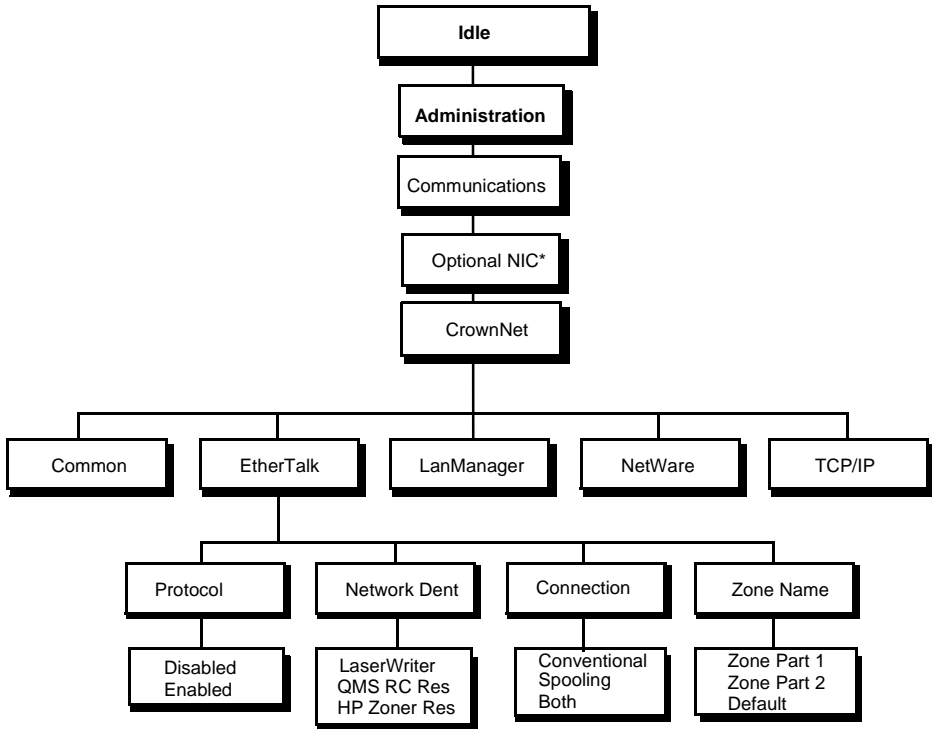

*\*Some printers may not have an Optional NIC interface menu.*



## Lan Manager Menu

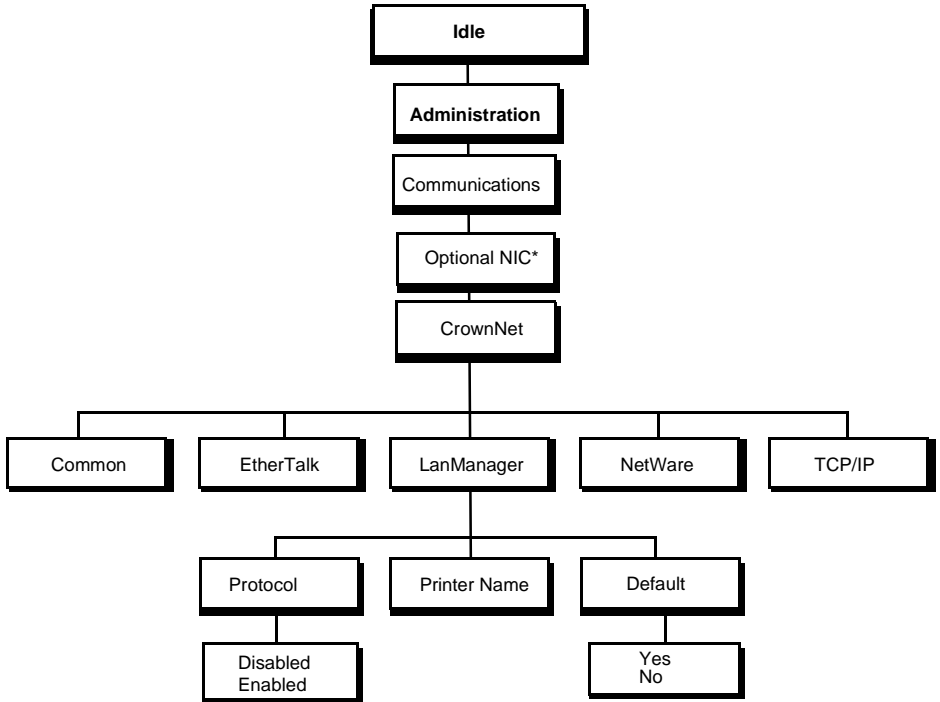

*\*Some printers may not have an Optional NIC interface menu.*

# NetWare Menu

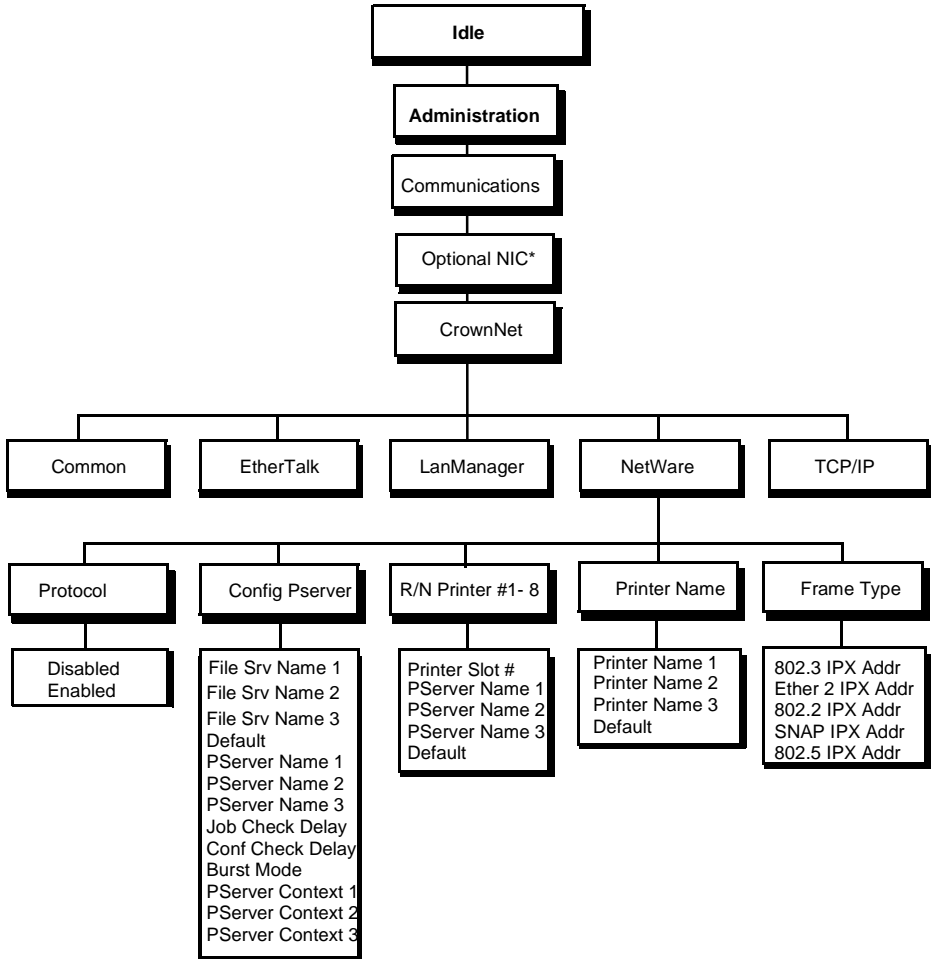

*\*Some printers may not have an Optional NIC interface menu.*

## TCP/IP Menu

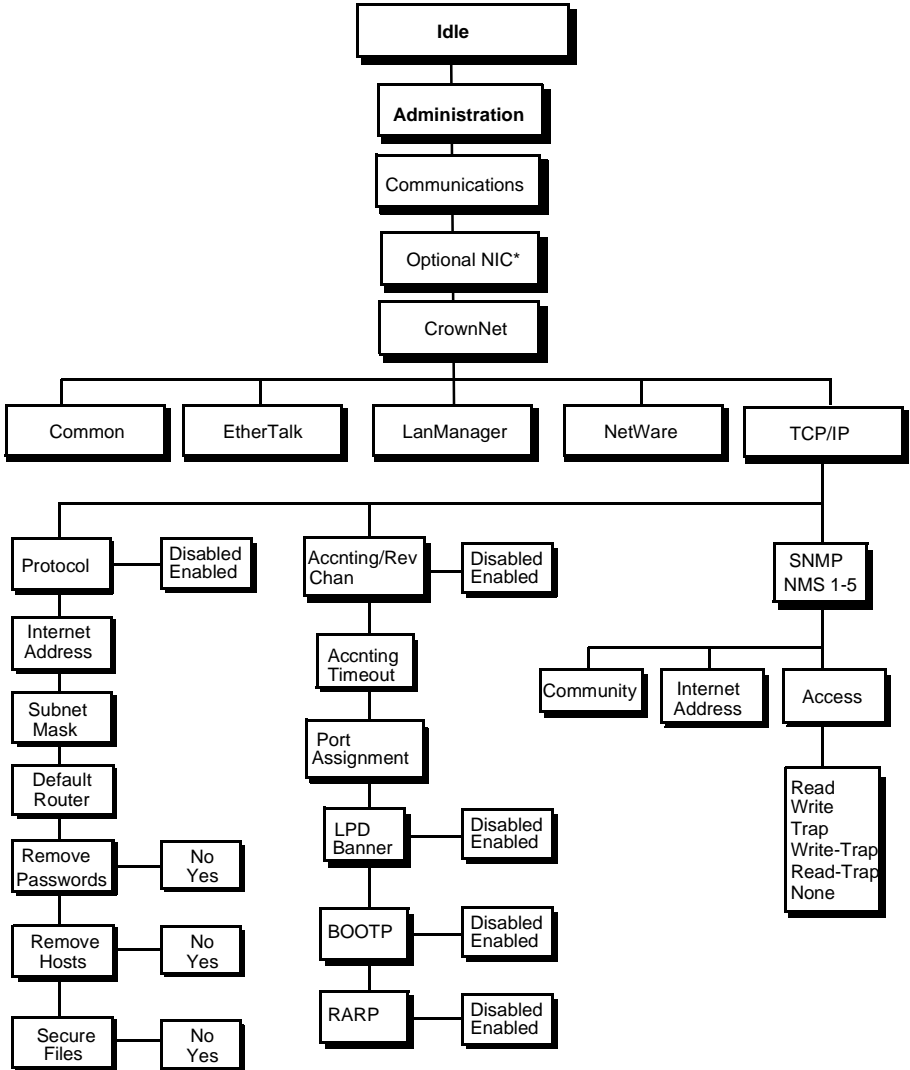

\*Some printers may not have an Optional NIC interface menu.





---

# Glossary

---

## **10Base2**

An IEEE standard for thin-wire Ethernet networks. It provides 10 megabits (10 million bits) transmission and Baseband signaling, and it has a maximum length of 607 feet (185 meters) per coax segment. See also *thin-wire Ethernet cable*.

## **10Base5**

An IEEE standard for thick-wire Ethernet networks. It provides 10 megabits (10 million bits) transmission and Baseband signaling, and it has a maximum length of 1640 feet (500 meters) per coax segment. See also *thick-wire Ethernet cable*.

---

## **10BaseT**

## **10BaseT**

An IEEE standard for twisted-pair Ethernet networks. It provides 10 megabits (10 million bits) transmission and Baseband signaling, and it is unshielded. See also *twisted-pair Ethernet cable*.

## **100BaseT**

An IEEE standard for twisted-pair Ethernet networks. It provides 100 megabits (100 million bits) transmission and Baseband signaling, and it is unshielded. See also *twisted-pair Ethernet cable*.

## **Agent**

See *network management agent*.

## **AppleTalk**

A local area network protocol developed by Apple Computer that can be used by both Apple and non-Apple computers. It operates on a bus topology at 230.4 kilobits (230,400 bits) per second and supports up to 254 nodes over a distance of 984 feet (300 meters) on twisted-pair cabling known as LocalTalk cable. See also *LocalTalk*.

## **ARP**

Address Resolution Protocol, the Internet protocol used to bind a high-level Internet address to a low-level physical hardware address. ARP works across a single physical network only and is limited to networks that support hardware broadcast.

## **AUI Connector (Attachment Unit Interface)**

A type of network connector used with thick-wire Ethernet cable. See *thick-wire Ethernet cable*.

## **Backbone Network**

A transmission facility designed to interconnect low-speed distribution channels or clusters of dispersed user devices.

## **Baseband Network**

A type of local area network that carries a single channel of communication signals.

### **BNC Connector**

A type of network connector used with thin-wire Ethernet cable. These connectors lock together when one is inserted into another and then rotated 90°. See *thin-wire Ethernet cable*.

### **BOOTP (Bootstrap Protocol)**

An application-level protocol used for reading UNIX operating environment parameters (such as the printer's Internet address) at printer startup.

### **Coaxial Cable**

A cable consisting of a center wire inside an insulated cylindrical shield. The shield minimizes electrical and radio frequency interference. Also called coax or coax cable. See also *thick-wire Ethernet cable* and *thin-wire Ethernet cable*.

### **Community**

A group of SNMP agents managed by an NMS (Network Management Station).

### **Community Name**

A password that enables SNMP access on an agent.

### **Community Profile**

That portion of the managed objects on an agent that a member of the community is allowed to manipulate.

### **Concentrator**

A communications device that combines signals from multiple sources, such as network workstations and printers, into one or more signals before sending them to their destination.

### **Datagram**

The basic unit of information passed along a TCP/IP network. It contains source and destination addresses as well as data.

### **Daughterboard**

A printed circuit board that attaches to another circuit board (often the main system board, or motherboard) to provide additional functionality or performance.

## **Dedicated Workstation**

### **Dedicated Workstation**

A computer on a network that is used to run only one network application. For example, a workstation that serves only as a print server is a dedicated workstation.

### **Default**

The value or setting built in to a system or program. Default settings can usually be changed.

### **Drop Cable**

In a local area network, a cable that connects a network device to the main network cable (or bus).

### **ELAP**

See *EtherTalk Link Access Protocol (ELAP)*.

### **Ethernet**

A linear local area network developed by Xerox in 1976. Presently an industry standard, Ethernet operates on a bus topology and uses CSMA/CD (Carrier Sense Multiple Access with Collision Detection) to regulate traffic. Each device, or node, is connected by either thin or thick coaxial cable or twisted-pair wiring. Based on the IEEE 802.3 standard, Ethernet operates at 10 megabits (10 million bits) per second. See also *thick-wire Ethernet cable*, *thin-wire Ethernet cable*, and *twisted-pair Ethernet cable*.

### **Ethernet Address**

A unique address assigned to each device on an Ethernet network.

### **EtherTalk**

A type of AppleTalk network that uses AppleTalk protocols on Ethernet cabling. It is actually a combination of the AppleTalk protocol and the EtherTalk Link Access Protocol (ELAP). See also *EtherTalk Link Access Protocol (ELAP)*.

### **EtherTalk Link Access Protocol (ELAP)**

The protocol used in an EtherTalk network. It is responsible for the transmission of data across the cabling and ensures data integrity during transmission.



### **FIFO**

An acronym for “first-in, first-out.” FIFO is a method of processing a print queue in which items are removed in the same order in which they were added.

### **File Server**

A network computer, often with a large hard disk, that not only stores files but also controls communication among workstations and manages shared resources such as printers and hard disks.

### **Float Memory**

Memory that can be allocated as necessary. When an interface has used its default allotment, it may use any available float memory to spool additional data. Float memory is allocated in a first-in, first-out (FIFO) manner.

### **Gateway**

A computer that attaches to two or more dissimilar networks and passes data from one to another. Data is routed from gateway to gateway until it can be delivered to its final destination directly across one physical network. Each gateway has two addresses—one for each network that it connects. See also *router*.

### **Handshake**

The signal exchange of readiness between two devices (for example, a computer and a printer) to send or receive data.

### **IEEE**

Institute of Electrical and Electronics Engineers, an organization of engineering and electronics professionals.

### **IEEE 802 Standards**

A set of standards developed by the Institute of Electrical and Electronics Engineers to define methods of access and control on local area networks.

### **Interface**

A shared boundary defined by common physical interconnection characteristics, signal characteristics, and meanings of interchanged signals.

## **Interface Card**

### **Interface Card**

Internal hardware used to link a workstation or printer physically to a LAN cable.

### **Internet**

One or more networks connected by intelligent nodes, each of which is referred to as an Internet routers (IR). See also *router*

### **Internet Address**

A 32-bit address assigned to hosts connected to a TCP/IP network. It consists of an Internet part and a local part. While this address is expressed to the network in binary form, it is usually written in decimal form. For example, the binary Internet address

10000000 00001010 00000010 00011110

is written as follows in decimal form:

128.10.2.30

### **IP (Internet Protocol)**

Internet Protocol, the Internet standard protocol that defines the Internet datagram as the unit of information passed across the Internet and provides the basis for connectionless, best-effort packet delivery service. The Internet protocol suite is often referred to as TCP/IP because IP is one of the two most fundamental protocols.

### **LLAP**

See *LocalTalk Link Access Protocol (LLAP)*.

### **Local Area Network (LAN)**

A data communication system providing physical connectivity and shared resources of devices operating in the same general area.

### **LocalTalk**

Cabling for local area networks using the AppleTalk protocol. See also *AppleTalk*.

### **LocalTalk Link Access Protocol (LLAP)**

The link-level protocol used in an AppleTalk network. It is responsible for transmission of data across the cabling and ensures data integrity during transmission.

### **Management Information Base (MIB)**

The information on an agent that can be accessed via SNMP.

### **Manager**

See *Network Management Station (NMS)*.

### **Motherboard**

The main circuit board containing the primary components of a computer system.

### **Network**

A group of computers and other devices connected by some type of communication facility.

### **Network Administrator**

The person in charge of operating a network. Also called a system administrator.

### **Network Management Agent**

A device exchanges network management information with an NMS; also referred to as an agent.

### **Network Management Station (NMS)**

The system responsible for managing the network; also referred to as a manager. The QMS CrownNet interface supports up to five NMSs.

### **Node**

A device attached to a network.

### **PAP (Printer Access Protocol)**

The AppleTalk protocol that manages interaction between workstations and print servers. It handles connection setup, maintenance, and termination as well as data transfer.

## **PConsole (Print Console)**

## **PConsole (Print Console)**

The NetWare Print Console utility that lets you set up print servers, set up print queues, and control network printing.

## **PING**

Packet Internet Groper, a program used in the Internet to test reachability of destinations by sending them an ICMP echo request and waiting for a reply.

## **Port**

The connector at the back of a computer to which a printer, hard disk, or network cable is connected.

## **Print Queue**

A list of print jobs on the file server waiting to be printed. Each print job must be sent to a print queue for storage until the print server is ready to send the job to the printer for printing.

## **Print Server**

A hardware or software product that services a network print spooler and sends the print data to a printer.

## **Print Spooler**

A hardware and/or software application that intercepts print jobs sent to a printer, temporarily storing the jobs on a disk until the printer is ready to print them. In this way, the print spooler frees the workstation to do other work. Because the print spooler performs all handshaking (a signal exchange of readiness to send or receive data) that occurs during printing, it releases the workstation early from the process so that it may be used to perform other tasks.

## **Printer Access Protocol**

See *PAP (Printer Access Protocol)*.

## **Protocol**

A set of rules that govern communication between computers. These rules apply to data format and the timing of messages sent and received.

### **RARP (Protocol)**

rarp (Reverse Address Resolution Protocol) is a low-level transport layer protocol that reads the Internet address at printer startup.

### **Remote Console**

Software that allows you to access printer information and change printer configuration settings from any workstation on the network

### **Remote Printer**

A printer connected directly to a network rather than to a workstation and shared by all network users.

### **RJ45 Connector**

A type of network connector used with twisted-pair Ethernet cable.

### **Router**

A computer that attaches to two or more similar networks and passes data from one to another. To accomplish this, it examines data addresses, determines the most efficient pathway to the destination, and routes the data accordingly. Each router has two addresses—one for each network that it connects. Routers are often referred to as gateways. See also *gateway*.

### **Server**

Any device on a network that provides a service. For example, a file server stores network files and application programs and a print server sends print data to a printer.

### **SNMP**

Simple Network Management Protocol, the Internet standard message-handling protocol used to monitor Internet networks and gateways.

### **Spooler**

See *print spooler*.

### **Spooler Mapping**

A NetWare command that translates the printer number used by an application into a print queue that NetWare can understand.

### **Subnet**

One physical network within an Internet. See also *Internet*.

## **Subnet Address**

### **Subnet Address**

The division of the Internet address's local part into a physical network part and a host part in order for the site to use a single Internet address for multiple physical networks or subnets. This division of the host part has no effect on the Internet address when it goes outside of the site. The process of using subnet addresses is known as subnet addressing, subnet routing, or subnetting.

### **Supervisor**

The NetWare username for the network or system administrator.

### **System Administrator**

The person in charge of operating a network. Also called a network administrator.

### **TCP**

Transmission Control Protocol, the Internet standard transport level protocol that allows a process on one device to send a stream of data to a process on another device.

### **TCP/IP**

Transmission Control Protocol/Internet Protocol, a communication protocol that allows networked computers to share files and system resources, such as hard disks and printers.

### **Thick-Wire Ethernet Cable**

Coaxial cable 0.4" (10 mm) in diameter that can connect stations up to 1640 feet (500 meters) apart. See also *coaxial cable* and *10Base5*.

### **Thin-Wire Ethernet Cable**

Coaxial cable 0.2" (5 mm) in diameter that can connect network stations over a distance of 607 feet (185 meters) apart. See also *coaxial cable* and *10Base2*.

### **Token**

A special signal or short message that circulates continuously among the nodes of a Token-Ring network. Only the workstation in possession of the token has the privilege of transmitting information.

## **Token-Ring Network**

A LAN ring (or closed loop) topology that uses token passing for data access. IBM's Token-Ring network, based on the IEEE 802.5 standard, operates at 4 or 16 megabits per second (Mbps)

## **Topology**

The physical arrangement and relationship of interconnected nodes and lines in a network.

## **Transceiver**

A device used for connecting a computer or printer to a network. Short for transmitter/receiver, a transceiver both transmits and receives signals.

## **Twisted-Pair Ethernet Cable**

Two separately insulated strands of wire twisted together. Twisted-pair cabling is used to reduce signal interference introduced by a strong radio source such as a nearby cable. See also *10BaseT*.

## **UDP (User Datagram Protocol)**

User Datagram Protocol, the Internet standard protocol that allows an application on one device to send a datagram to an application on another device.

## **View**

The objects managed by an agent which are visible to a community.

## **Workstation**

A personal computer connected to a network and used to accomplish specific tasks using application and utility software. See also *dedicated workstation*.

## **Zone**

A subgroup of users within a larger group of interconnected networks.







---

# Index

---

**10Base2** G-1  
**10Base5** G-1  
**10BaseT** G-2  
**100BaseTX** G-2  
**802 standards, IEEE** G-5  
**802.2 IPX Addr** 2-44  
**802.3 IPX Addr** 2-43  
**802.5 IPX Addr** 2-45

## **A**

### **Access option (SNMP)**

Privileges 2-57

Traps C-2

### **Accntng Timeout submenu** 2-52

### **Accntng/Revchan submenu** 2-51

### **Accounting** C-8

Connection timeout 2-51

File format C-10

File format, alternative C-12

File format, standard C-11

Packet format C-14

Spooling C-14

TCP/IP, disabling 2-51

TCP/IP, enabling 2-51

TCP/IP, setting timeout 2-51

Timeout 2-52

Timeout, setting 2-51

### **Address** 7-14

802.2, frame type 2-44

802.3, frame type 2-43

802.5, frame type 2-45

Ether2, frame type 2-43

Ethernet G-4

Gateway 2-49

Hardware, network interface 2-11

Internet 2-47, G-6

Internet, setting via TCP/IP 7-2

Internet, SNMP NMS 2-56

Network 2-47

Router 2-49

---

- SNAP, frame type 2-44
- Subnet 2-48, G-10
- Address Resolution Protocol** G-2
- ADMIN directory** 7-18
- Administrator**
  - Network G-7
  - System G-10
- Agent** G-2, G-7
- AIX**
  - CrownAdmin 3, opening 4-4
  - CrownAdmin 3, troubleshooting 9-4
  - Help 4-8
  - Online user's guide 4-8
  - Troubleshooting 9-12
  - Troubleshooting CrownAdmin 3 9-4
  - Version 7-2
- Alternative format** C-8
- AppleTalk** G-2
  - Printer Access Protocol G-7
- ARP** G-2
- Attachment Unit Interface**
  - See AUI connector
- AUI connector** G-2
  
- B**
- Backbone network** G-2
- Backchannel**
  - Reverse channel 2-51
- Baseband network** G-2
- BCP**
  - See Binary Communications Protocol and PS Protocol
- Binary Communications Protocol** 2-58
  - Advantages 2-61
  - Implementation 2-61
  - Quoting mechanism 2-60
  - See also PS Protocol
- Bindery File Server**
  - Naming 2-31
- Bindery Print Server**
  - Naming 2-33
- BNC connector** G-3

- bootp** 7-3, G-3
- BOOTP configuration**
  - Enable/disable BOOTP 2-54
- BOOTP menu** 2-54
- Bootstrap Protocol** 7-3, G-3
- BSD UNIX** 7-24
  - Troubleshooting 9-12
- Buffer, spool** 2-5
- Burst Mode**
  - Print server 2-35
  
- C**
- Cable**
  - Coaxial G-3, G-10
  - Drop G-4
  - Thick-wire Ethernet G-10
  - Thin-wire Ethernet G-10
  - Twisted-pair G-11
  - twisted-pair G-11
  - Twisted-pair Ethernet G-11
- Capability file, printer** 7-25
- Card, interface** G-6
- cat command** 7-14, 7-16
- cd command** 7-17
- Chooser, Macintosh**
  - Troubleshooting 9-5
  - Version 9-6
- Coaxial cable** G-3
- Commands**
  - %%For 7-19
  - %%Routing 7-20
  - %%Title 7-19
  - cat 7-14, 7-16
  - cd 7-17
  - dir 7-17
  - FTP 7-9
  - ftp 7-10, 7-13
  - get 7-23
  - lpc 7-26
  - lpq 7-27
  - lpr 7-25, 7-26
  - mput 7-22

- put 7-21, 7-22
- pwd 7-16
- qpr 7-5
- quit 7-11
- type 7-21
- Common Menu** D-3
- Common menu** 2-4, 2-5, 2-9, 2-14
  - Config Page option 2-12
  - Factory Reset option 2-12
  - HW Address option 2-11
  - Min K Spool option 2-5
  - Mode option 2-4
  - Ring Speed option 2-13
  - Soft Reset option 2-13
  - Spooling option 2-10
- Community** C-3, G-3
  - Name C-3, G-3
  - Profile G-3
  - SNMP NMS 2-55
- Community option** 2-55
- Concentrator** G-3
- Config Page option** 2-12
- Config PServer submenu** 2-29
  - Burst Mode 2-35
  - Default 2-32
  - File Srv Name 2-31
  - Job check delay 2-35
  - Job check delay setting 2-34
  - NetWare menu 2-29
  - PServer Context 2-36
  - PServer Name 2-33
- Config RPrinter submenu** 2-37
  - Define RPrinter1-8 submenus 2-37
- Configuration**
  - Changes don't take effect 9-3
  - Changing settings 2-2
  - Common menu 2-4, 2-9
  - Control panel 2-2
  - CrownAdmin 3 2-2
  - Ethernet network 2-4, 2-9
  - EtherTalk menu 2-18
  - Host, to use LPD 7-24
  - Menus 2-2

- NetWare protocol 2-27
- Print server 2-29
- Remote Console 2-3
- See also specific topics
- TCP/IP menu 2-45
- Token-Ring network 2-4, 2-9
- Configuration page**
  - CrownNet interface 2-12
- Connection option** 2-21
  - Both 2-21
  - Conventional 2-21
  - Spooling 2-21
- Connector**
  - AUI G-2
  - BNC G-3
  - RJ45 G-9
- Control panel**
  - Configuration 2-2
  - Macintosh, Troubleshooting 9-5
- Conventions, typographic** 1-7
- CrownAdmin**
  - Troubleshooting, DOS 9-3
- CrownAdmin 3**
  - About 4-3
  - AIX, closing 4-14
  - AIX, opening 4-4
  - Closing, AIX 4-14
  - Closing, DOS 3-4
  - Closing, HP-UX 4-14
  - Closing, Macintosh 4-15
  - Closing, Solaris 4-14
  - Closing, SunOS 4-14
  - Closing, Windows 4-14
  - Configuration 2-2
  - Configuration buttons 4-9
  - DOS, closing 3-4
  - DOS, opening 3-2
  - EtherTalk zone 4-4
  - Filters, Macintosh 4-6
  - HP-UX, closing 4-14
  - HP-UX, opening 4-4
  - Macintosh, closing 4-15
  - Online user's guide 4-8

- Opening, AIX 4-4
- Opening, DOS 3-2
- Opening, HP-UX 4-4
- Opening, Solaris 4-4
- Opening, SunOS 4-4
- Opening, Windows 4-4
- Printer name, Macintosh 4-7
- Remote Console 4-13
- Solaris, closing 4-14
- Solaris, opening 4-4
- SunOS, closing 4-14
- SunOS, opening 4-4
- Troubleshooting, AIX 9-4
- Troubleshooting, HP-UX 9-4
- Troubleshooting, Solaris 9-4
- Troubleshooting, SunOS 9-4
- Troubleshooting, UNIX 9-4
- Troubleshooting, Windows 9-4
- User's guide, online 4-8
- Windows, closing 4-14
- Windows, opening 4-4

**CrownNet**

- Configuration 2-4, 2-9
- Configuration page 2-12
- NIC installation 2-2
- NIC, overview 1-2
- Specifications, NIC B-2

**CrownNet Administration Utilities**

- See CrownAdmin 3

**CrownNet Manager 5-3, 5-8**

**CrownNet Manager (OS/2)**

- Closing, OS/2 5-8
- Help menu 5-4
- Install menu 5-5
- Introduction 5-2
- Logfile menu 5-5
- Opening, OS/2 5-3
- Printing process 5-2
- Remove menu 5-6
- Status menu 5-6

**CrownNet Print Utility 6-2**

- LAN Server/LAN Manager Workstation Service 6-2

- Microsoft Windows Network support 6-2

**CROWNNET.LOG file 5-5**

**Current page C-12**

**Customer Response Center (CRC), QMS A-3**

**Customer support, QMS A-2**

## D

**Datagram G-3**

**Daughterboard G-3**

**Dedicated workstation G-4**

**Def Job Prio submenu 2-62**

**Default G-4**

- Def Job Prio submenu 2-62
- Default job priority 2-62
- Default Router submenu 2-49
- Network interface, resetting 2-12

**Default menu 2-26, 2-40, 2-42**

**Default option**

- EtherTalk zone name 2-24
- NetWare file server name 2-32

**Default Router submenu 2-49**

**dir command 7-17**

**Directories, printer**

- ADMIN directory 7-18
- Changing 7-17
- DISK directory 7-18
- Displaying 7-16
- HELP directory 7-18
- JOBS directory 7-19
- Listing contents 7-17
- NO\_DOC\_CMDDS directory 7-19
- USR 7-20

**DISK directory 7-18**

**DOC**

- NO\_DOC\_CMDDS directory 7-19
- See also Commands

**Documentation**

- Conventions, typographic 1-7
- Overview 1-3
- Overview of this manual 1-5

- Printer user's guide 1-4
- QMS Crown Remote Console User's Guide 1-3
- QMS CrownNet 1.19-D Setup Guide 1-3
- Relevant 1-4
- Standard 1-3

## **DOS**

- CrownAdmin 3, closing 3-4
- CrownAdmin 3, opening 3-2
- CrownAdmin, troubleshooting 9-3
- Remote Console, using 3-2
- Troubleshooting CrownAdmin 9-3

## **Drop cable G-4**

## **E**

### **ELAP G-4**

### **EMM386 9-3**

### **Emulation**

- Network interface 2-5

### **Emulation option 2-5**

- Common menu 2-5

### **Enabling 2-29**

### **Error messages C-8, C-11, C-13**

### **Ether2 IPX Addr 2-43**

### **Ethernet G-4**

- 10Base2 G-1
- 10Base5 G-1
- 10BaseT G-2
- Address G-4
- Cable, twisted-pair G-11
- Configuration 2-4, 2-9
- See also Network Interface

### **EtherTalk G-4**

- Connection submenu 2-21
- Disabling 2-18
- Enabling 2-18
- Icons, troubleshooting 9-5
- Menu D-4
- Mode submenu 2-18
- Printer name 4-7
- Protocol, disabling 2-18

- Protocol, enabling 2-18
- Specifications B-4
- Troubleshooting 9-5
- Zone G-11
- Zone name 2-23
- Zone, setting 4-4

### **EtherTalk Link Access Protocol G-4**

### **EtherTalk menu**

- Configuration 2-18
- Connection option 2-21
- Network Ident menu 2-19
- Protocol submenu 2-18
- Zone Name option 2-23

### **EtherTalk zone, setting 4-4**

### **Exiting from printer via FTP 7-11**

## **F**

### **Factory defaults**

- See Defaults

### **Factory Reset option 2-12**

### **FIFO 2-6, G-5**

### **File format C-13**

### **File server G-5**

- Name on print server 2-31
- Resetting to default 2-32

### **File Srv Name**

- For print server 2-31

### **File Transfer Protocol 7-8**

### **Filename C-9**

### **Filters**

- Macintosh 4-6
- Macintosh, using 4-6

### **First-in, first-out 2-6, G-5**

### **Flash ROM**

- System software, updating 9-13

### **Float memory 2-6, G-5**

### **For command 7-19**

### **Format, status messages C-8**

### **Frame Type option 2-42**

- 802.2 IPX Addr 2-44
- 802.3 IPX Addr 2-43
- 802.5 IPX Addr 2-45

Ether2 IPX Addr 2-43

SNAP IPX Addr 2-44

## **FTP** 7-8

Commands 7-9

Exiting from printer 7-11

Logging in to printer 7-10

Specifications B-9

**ftp command** 7-10, 7-13

## **G**

**Gateway** G-5

**get command** 7-23

**Graphics, wrong format**

Troubleshooting 9-10

## **H**

**Handshake** G-5

**Hardware address**

Network interface 2-11

**Header pages** 7-19

**Help**

AIX 4-8

HP-UX 4-8

Solaris/SunOS 4-8

Windows 4-8

**HELP directory** 7-18

**Help menu, CrownNet Manager (OS/2)**

5-4

**Host address file** 7-14

Creating 7-15

Downloading 7-15

Format 7-15

HOST.EQ 7-16

HOST.EQ file 7-15

Listing contents 7-16

Locking 2-51

Removing 2-50

**Host table, TCP/IP** 7-25

**HOST.EQ file** 7-15, 7-18

**Hostname** C-11, C-12

**HP Zoner Res option** 2-20

**HP Zoner Responder** 2-20

## **HP-UX**

CrownAdmin 3, opening 4-4

CrownAdmin 3, troubleshooting 9-4

Help 4-8

Online user's guide 4-8

Troubleshooting 9-12

Troubleshooting CrownAdmin 3 9-4

Version 7-2

Versions, differences 7-27

## **HW Address option**

Common menu 2-11

## **I**

### **Icons**

EtherTalk, troubleshooting 9-5

### **IEEE** G-5

802 standards G-5

### **Install menu, CrownNet Manager (OS/2)** 5-5

### **Installation**

CrownNet NIC 2-2

### **Institute of Electrical and Electronics Engineers**

See IEEE

### **Interface** C-11, G-5

Configuration 2-4, 2-9

See also network interface

### **Interface card** G-6

### **Internet** A-3, G-6

Address G-6

Address, classes A, B, C C-7

Address, setting via TCP/IP 7-2

ARP G-2

IP G-6

Routing C-6

### **Internet Address option** 2-56

### **Internet Address submenu**

TCP/IP menu 2-47

### **Internet Protocol**

See IP

### **IP** G-6

### **IPX address**

- 802.2 2-44
- 802.3 2-43
- 802.5 2-45
- Ether2 2-43
- SNAP 2-44

## **J**

- Jams, media** 9-3
- Job Check Delay**
  - Print server 2-35
- Job Check Delay Setting**
  - Print server 2-34
- Job title** C-11, C-12
- JOBS directory** 7-19

## **L**

- LAN** G-6
- LAN Manager menu**
  - Protocol submenu 2-25
- Lan Manager Menu** D-5
- LAN Manager/LAN Server**
  - Default menu 2-26
  - Printer Name menu 2-25
  - See also OS/2
  - Specifications B-5
  - Troubleshooting 9-7
- LAN Server**
  - See LAN Manager/LAN Server
- LAN Server/LAN Manager Workstation Service** 6-2
- LaserPrep**
  - Version 9-6
- LaserWriter**
  - Version 9-6
- LaserWriter option** 2-19
- Line Printer Daemon**
  - See LPD
- LLAP** G-7
- Local area network** G-6
- LocalTalk** G-6
- LocalTalk Link Access Protocol** G-7
- Locking files** 2-51

## **Log file, CrownNet Manager**

- Erasing 5-5
- Printing 5-5
- Switching to status display 5-7
- Truncating 5-6
- Viewing 5-6

## **Logfile menu, CrownNet Manager (OS/2)** 5-5

## **Logging in to printer via ftp** 7-10

**LPC** 7-26

**lpc command** 7-26

**LPD** 7-24

- Using 7-26

**LPD banner page** 2-54

**LPQ** 7-27

**lpq command** 7-27, C-10

**lpr command** 7-25, 7-26

## **M**

### **Macintosh**

- CrownAdmin 3
  - Closing 4-15
- LaserPrep, version 9-6
- LaserWriter, version 9-6
- PrintMonitor, version 9-6
- Re-initialization problems 9-6
- Spooling 2-21
- System Folder 9-6
- System requirements 9-6
- System software, updating 9-13
- System, version 9-6
- Zone G-11

### **Management Information Base** C-2

- See MIB

### **Management Information Base (MIB)**

- C-3

### **Manager** G-7

#### **Manual**

- Overview 1-5

### **Mapping, spooler** G-9

### **Memory**

- Float G-5

**Memory, float** 2-6

**Menus**

Configuration 2-2

**Menus, printer** 2-18

**MIB** C-2, C-3, G-7

**Microsoft Windows Network** 6-2

**Min K Spool option** 2-5

**Mode**

Network interface 2-4

Selecting 2-18

**Mode option** 2-4

**Mode submenu** 2-33, 2-39, 2-46, 2-54, 2-55

**Motherboard** G-7

**mput command** 7-22

**MultiFinder** 2-21

**N**

**Name**

Community G-3

Printer server, R/N printers 2-40

Printer, LAN Manager/LAN Server menu 2-25, 2-26

Printer, NetWare 2-42

User C-11, C-12

**NDS Print Server**

Naming 2-36

**NetWare**

Configuration 2-27

Default menu, printer 2-42

Password, hidden 2-27

Print won't connect to a file server 9-9

Security 2-27

Specifications B-6, B-7

Spooler mapping G-9

Supervisor G-10

Troubleshooting 9-8

**NetWare Menu** D-6

**NetWare menu**

Config PServer submenu 2-29, 2-31, 2-32

Config RPrinter submenu 2-37

Frame Type option 2-42

Mode submenu 2-33, 2-39

Printer Name submenu 2-41

Protocol submenu 2-29

**Network** G-7

10Base2 G-1

10Base5 G-1

10BaseT G-2

Address 2-47

Administrator G-7

Backbone G-2

Baseband G-2

baseband G-2

Ethernet G-4

Icon, troubleshooting 9-5

LAN G-6

Local area network G-6

Management C-2

PConsole G-8

SNMP C-2

Supported 1-2

Token-Ring G-10, G-11

Topology G-11

Troubleshooting 9-5

**Network Ident menu** 2-20

HP Zoner Res option 2-20

**Network Ident. menu** 2-19

LaserWriter option 2-19

**Network interface**

Configuration page 2-12

Disabling 2-4

Emulation 2-5

Enabling 2-4

Hardware address 2-11

Reset default settings 2-12

Routing, source 2-14

Soft reset 2-13

Source routing 2-14

Spool buffer 2-5

Spooling 2-10

**Network management agent** G-7

**Network Management Station**

See NMS



## **Network menu**

- Preferences command 4-6
- Remote-Console command 4-13
- Set EtherTalk Zone command 4-4
- Set Printer Name command 4-7

## **Network printer**

- Config RPrinter submenu 2-37
- Connection submenu 2-21
- Interface, enabling 2-18
- Mode submenu 2-18

## **New Flash Image menu** 9-13

## **NMS** G-7

## **NO\_DOC\_CMDS** directory 7-19

## **Node** G-7

## **Novell**

- See NetWare

## **O**

### **OS/2**

- CrownNet Manager, closing 5-8
- CrownNet Manager, opening 5-3
- See also LAN Manager/LAN Server

## **P**

### **Packet format** C-14

### **Packet Internet Groper**

- See PING

### **Page** C-12

- See type of page

### **Page count** C-11, C-12

### **PAP** G-7

### **Paper jams, troubleshooting** 9-3

### **Parallel**

- PS Protocol menu 2-8

### **PASSWD.FTP** file 7-11, 7-14, 7-18

### **Password**

- Correct 7-13
- Deleting 2-50
- File 7-11
- Incorrect 7-13
- Locking 2-51
- Logging in with 7-13

### NetWare 2-27

### PASSWD.FTP 7-11, 7-14

### Password file 7-11

### Print server 2-27

## **Password file** 7-11

### Creating 7-11

### Downloading 7-12

### Format 7-11

### Listing contents 7-14

## **PC**

### System software, updating 9-13

## **PConsole** G-8

## **PCONSOLE** utility

### Troubleshooting 9-10

## **PING** G-8

## **Port** G-8

### Assignment, TCP/IP 2-53

### Number C-10

### Printer, troubleshooting 9-6

## **Port Assignment submenu** 2-53

## **Preferences command** 4-6

## **Print** 9-3

## **Print Console** G-8

## **Print queue** G-8

### Troubleshooting 9-9, 9-11

## **Print server** G-8

### Burst Mode 2-35

### Config PServer submenu 2-29

### Configuring (see Config PServer submenu)

### Job check delay 2-35

### Job check delay setting 2-34

### Name 2-33

### Name for remote/network printer 2-38

### Password 2-27

### PServer Context 2-36

### Security 2-27

## **Print spooler** G-8

## **Print utility, Windows** 6-2

## **Printcap** entry 7-25

## **Printer**

### Error messages C-8

### Hostname C-11

- Name, EtherTalk network, setting 4-7
- Port, troubleshooting 9-6
- Remote G-9
- Printer Access Protocol** G-7
- Printer control panel**
  - See control panel
- Printer hostname** C-12
- Printer Name**
  - Netware 2-40
- Printer Name menu** 2-25
- Printer Slot #** 2-38
- Printer Web Page**
  - Accounting page 8-9
  - Consumable status page 8-8
  - General settings page 8-6
  - Help system 8-13
  - Home page 8-4
  - Online help page 8-12
  - Operator control page 8-5
  - Printer jobs page 8-7
  - QMS home page 8-11
  - System support page 8-10
- Printing**
  - Files 7-21
  - Job doesn't print, troubleshooting 9-9
  - Printer doesn't print 9-2
  - qpr command 7-5
  - Troubleshooting 9-9, 9-10
- PrintMonitor** 2-21
  - Version 9-6
- Problems**
  - See Troubleshooting
- Profile, community** G-3
- Protocol** 7-4, G-8
  - bootp 7-3
  - Bootstrap Protocol 7-3
  - EtherTalk G-4
  - File Transfer Protocol (see FTP)
  - FTP 7-8
  - LAN Manager/LAN Server, disabling 2-25
  - LAN Manager/LAN Server, enabling 2-25

- NetWare, disabling 2-29
- NetWare, enabling 2-29
- Printer Access Protocol G-7
- rarp 7-4
- Supported 1-2
- Protocol submenu** 2-46, 2-54, 2-55
  - BOOTP menu 2-54
  - EtherTalk menu 2-18
  - LAN Manager menu 2-25
  - NetWare menu 2-29
  - RARP menu 2-55
  - TCP/IP menu 2-46
- PS Protocol**
  - Advantages 2-61
  - Implementation 2-61
  - Quoted character 2-60
  - Quoting mechanism 2-60
- PS Protocol configuration**
  - PS Protocol 2-58
- PS Protocol menu**
  - Parallel 2-8
- PS Protocol submenu** 2-58
- PServer Context** 2-36
  - Print server 2-36
- PServer Name** 2-33, 2-38
  - Remote/network printer 2-38
- put command** 7-21, 7-22
- pwd command** 7-16

## Q

- qef command (TCP/IP)** C-8, C-14
- Q-FAX** A-2
- QMS**
  - Customer Response Center (CRC)
    - A-3
  - World-wide offices A-5
- QMS Crown Remote Console User's Guide** 1-3
- QMS CrownNet 1.19-D Setup Guide**
  - 1-3
- QMS LPD**
  - See LPD

**QMS RC Res option** 2-20  
**qpr command** 7-5  
**Quality of printout, troubleshooting**  
9-3  
**Queue, print** G-8  
**quit command** 7-11  
**Quoted character** 2-60

## **R**

**R/N printer**  
Configuration 2-37  
**R/N Printer option** 2-38  
**R/N Printer x menu**  
Default option 2-40  
**rarp** 7-4, G-9  
**RARP configuration**  
Enable/disable RARP 2-55  
**RARP menu** 2-55  
**Re-initialization problems, Macintosh**  
9-6  
**Remote Console** 4-13, G-9  
Accessing 4-13  
Closing 4-14  
Configuration 2-3  
DOS, accessing 3-2  
DOS, closing 3-3  
Macintosh, multiple sessions 4-14  
Multiple sessions 3-3  
QMS Crown Remote Console User's  
Guide 1-3  
Remote Console Responder 2-20  
TCP/IP, port assignment 2-53  
**Remote Console Responder** 2-20  
**Remote printer** G-9  
Config RPrinter submenu 2-37  
Configuration 2-37  
Not connected  
Troubleshooting 9-10  
**Remote-Console command** 4-13  
**Remove Hosts submenu** 2-50  
**Remove menu, CrownNet Manager**  
(OS/2) 5-6

**Remove Passwords submenu** 2-50  
**Reset, soft** 2-13  
**Reverse Address Resolution Protocol**  
7-4, G-9  
**Reverse channel (TCP/IP)** C-8  
**Reverse channel, TCP/IP** C-8, C-13  
Disabling 2-51  
Enabling 2-51  
Information C-15  
Log C-9  
Packet format C-15  
**Ring Speed option** 2-13  
**RJ45 connector** G-9  
**Route-guess table** 2-15  
**Router** G-9  
**Routing command** 7-20  
**Routing, source** 2-14

## **S**

**SAP route-guess table** 2-15  
**SCO**  
Version 7-2  
**Screen displays do not print,**  
**troubleshooting** 9-8  
**Secure Files submenu** 2-51  
**Security**  
NetWare 2-27  
Print server 2-27  
**Server** G-9  
File server G-5  
Print server G-8  
**Service**  
United States A-4  
**Service Access Point (SAP)**  
**route-guess table** 2-15  
**Set EtherTalk Zone command** 4-4  
**Set Printer Name command** 4-7  
**Settings** 2-2  
**SGI**  
Troubleshooting 9-12  
Version 7-2  
**Simple Network Management Protocol**

- See SNMP
- Slot**
  - See Printer Slot #
- SNAP IPX Addr** 2-44
- SNMP** C-2, G-9
  - Community C-3, G-3
  - Community name C-3, G-3
  - Community profile G-3
  - Configuration 2-55
  - Definition C-2
  - Management Information Base (MIB)
    - C-2, C-3
  - MIB C-2, C-3, G-7
  - Overview C-2
  - Specifications B-10
  - Traps C-2
  - View G-11
- SNMP NMSx submenu** 2-55, 2-56, 2-57
  - Access option 2-57
  - Community option 2-55
  - Internet Address option 2-56
- Soft Reset**
  - Common Menu D-3
- Soft Reset option** 2-13
- Solaris**
  - CrownAdmin 3, opening 4-4
  - CrownAdmin 3, troubleshooting 9-4
  - Help 4-8
  - Online user's guide 4-8
  - Troubleshooting CrownAdmin 3 9-4
  - Version 7-2
- Source** C-12
- Source routing** 2-14
  - SAP route-guess table 2-15
  - Transparent bridge 2-15
- Source Routing option** 2-14
- Source routing, identifying** 2-14
- Specifications**
  - CrownNet NIC, features B-2
  - CrownNet NIC, network attachments
    - B-3
  - CrownNet NIC, networks B-3
  - CrownNet NIC, protocols B-3

- EtherTalk, connections B-4
- EtherTalk, features B-4
- EtherTalk, protocols B-4
- LAN Manager/LAN Server,
  - connections B-5
- LAN Manager/LAN Server, features
  - B-5, B-6
- LAN Manager/LAN Server, protocols
  - B-6
- NetWare, Bindery connections B-6
- NetWare, features B-7
- NetWare, NDS connections B-7
- NetWare, protocols B-8
- TCP/IP, connections B-8
- TCP/IP, features B-8
- TCP/IP, FTP B-9
- TCP/IP, protocols B-9
- TCP/IP, SNMP B-10
- TCP/IP, Telnet B-10
- Speed, Token-Ring network** 2-13
- Spool**
  - Spooler mapping G-9
- Spool buffer** 2-5, 2-6
- Spool folder** 2-21
- Spooler**
  - Mapping G-9
  - Print G-8
  - Print spooler G-8
- Spooling** 2-21, 7-24, 7-26
  - Accounting C-14
  - Network interface 2-10
- Spooling option**
  - Common menu 2-10
- Status** C-12
- Status display, CrownNet Manager**
  - Refreshing 5-7
  - See also Status file
  - Switching to log file 5-7
- Status file, CrownNet Manager**
  - See also Status display
  - Viewing 5-7
- Status menu, CrownNet Manager (OS/2)** 5-6

**Status message format** C-8  
**Status, printer, monitoring** 7-26  
**Subnet** C-5, G-9  
    Address G-10  
    Subnet address 2-48  
**Subnet mask** C-6  
**Subnet Mask submenu** 2-48  
**Sun**  
    See Solaris or SunOS  
**SunOS**  
    CrownAdmin 3, opening 4-4  
    CrownAdmin 3, troubleshooting 9-4  
    Help 4-8  
    Online user's guide 4-8  
    Troubleshooting CrownAdmin 3 9-4  
    Version 7-2  
**Supervisor** G-10  
**Support, QMS**  
    Customer A-2  
    Internet A-3  
    Technical A-3  
    World-wide A-5  
**SYS V**  
    Troubleshooting 9-12, 9-13  
    Version 7-2  
**System administrator** G-10  
**System Folder, Macintosh** 9-6  
**System software**  
    Updating 9-13  
**System, Macintosh**  
    Requirements 9-6  
    Troubleshooting 9-6  
    Version 9-6

## **T**

**TCP** G-10  
**TCP/IP** G-10  
    /etc/hosts file 7-25  
    /etc/printcap file 7-25  
    Accounting C-8  
    Host table 7-25  
    Internet address classes C-7

    Internet routing C-6  
    qef command C-8  
    Reverse channel C-8  
    Specifications B-8  
    Subnet C-5  
    Subnet mask C-6  
    Troubleshooting 9-12

### **TCP/IP configuration**

    Accounting 2-51  
    Backchannel 2-51  
    Enable/disable TCP/IP 2-46  
    Gateway addresses 2-49  
    Internet address 2-47  
    Port assignment 2-53  
    Remove hosts 2-50  
    Remove passwords 2-50  
    Reverse channel 2-51  
    Router address 2-49  
    Secure files 2-51  
    SNMP configuration 2-55  
    Subnet address 2-48  
    x 2-54

### **TCP/IP Menu** D-7

#### **TCP/IP menu** 2-46

    Accnting Timeout submenu 2-52  
    Accnting/Revchan submenu 2-51  
    Configuration 2-45  
    Default Router submenu 2-49  
    Internet Address submenu 2-47  
    LPD banner page submenu 2-54  
    Port Assignment submenu 2-53  
    Remove Hosts submenu 2-50  
    Remove Passwords submenu 2-50  
    Secure Files submenu 2-51  
    SNMP NMSx submenu 2-55  
    Subnet Mask submenu 2-48

#### **Technical support, QMS** A-3

#### **Telnet**

    Specifications B-10

#### **Thick-wire Ethernet cable** G-10

#### **Thin-wire Ethernet cable** G-10

#### **Time** C-11, C-12

#### **Timeout**

- Accounting 2-52
- Accounting, TCP/IP 2-51
- Title** C-11, C-12
- Title command** 7-19
- Token** G-10
- Token-Ring** 2-14, G-10
  - Configuration 2-4, 2-9
  - Network G-11
  - See also Network Interface
  - Speed, setting 2-13
- Topology** G-11
- Transceiver** G-11
- Transferring files** 7-21
- Transmission Control Protocol** G-10
- Transmission Control Protocol/Internet Protocol**
  - See TCP/IP G-10
- Transparent bridge** 2-15
- Traps** C-2
- Troubleshooting** 9-2
  - AIX 9-12
  - AIX, CrownAdmin 3 for 9-4
  - BSD UNIX 9-12
  - Chooser, Macintosh 9-5
  - Configuration changes don't take effect 9-3
  - Control Panel, Macintosh 9-5
  - DOS, CrownAdmin for 9-3
  - EtherTalk 9-5
  - EtherTalk icons 9-5
  - Graphics, wrong format 9-10
  - HP-UX 9-12
  - HP-UX, CrownAdmin 3 for 9-4
  - Icons, EtherTalk 9-5
  - Icons, Network 9-5
  - LAN Manager/LAN Server 9-7
  - Media jams 9-3
  - NetWare 9-8
  - Network icons 9-5
  - Network services 9-5
  - PCONSOLE utility 9-10
  - Port, printer 9-6
  - Print job doesn't print 9-9

- Print jobs 9-10
- Print quality, poor 9-3
- Print queue 9-9, 9-11
- Printer doesn't print 9-2
- Printing 9-9, 9-10
- Remote printer not connected 9-10
- Screen displays 9-8
- SGI 9-12
- Solaris, CrownAdmin 3 for 9-4
- SunOS, CrownAdmin 3 for 9-4
- SYS V 9-12
- System, Macintosh 9-6
- TCP/IP 9-12
- UNIX 9-12
  - UNIX, AIX 9-12
  - UNIX, BSD 9-12
  - UNIX, CrownAdmin 3 for 9-4
  - UNIX, HP-UX 9-12
  - UNIX, SGI 9-12
  - UNIX, SYS V 9-13
  - Windows, CrownAdmin 3 for 9-4
- Twisted-pair cable** G-11
- Twisted-pair Ethernet cable** G-11
- type command** 7-21
- Typographic conventions** 1-7

## U

- UDP** G-11

### UNIX

- AIX, troubleshooting 9-12
- AIX, version 7-2
- bootp G-3
- Bootstrap Protocol G-3
- BSD 7-24
- BSD UNIX, troubleshooting 9-12
- Commands (see Commands) 7-13
- CrownAdmin 3, troubleshooting 9-4
- HP-UX, troubleshooting 9-12
- HP-UX, version 7-2
- HP-UX, versions, differences 7-27
- rarp G-9

Reverse Address Resolution Protocol  
G-9

SCO, version 7-2

SGL, troubleshooting 9-12

SGL, version 7-2

Solaris, version 7-2

SunOS, version 7-2

SYS V , troubleshooting 9-13

SYS V, troubleshooting 9-12

SYS V, version 7-2

Troubleshooting 9-12

Troubleshooting CrownAdmin 3 9-4

**UNIX Host Software** 7-2

**UNIX Ipq** C-10

**Updating system software** 9-13

**User Datagram Protocol** G-11

**User name** C-11, C-12

**Using Soft Reset**

Common Menu D-3

**USR directory** 7-20

## **V**

**Verbose mode** C-10

**View** G-11

## **W**

**Web Page Help System** 8-13

**Windows**

CrownAdmin 3, closing 4-14

CrownAdmin 3, opening 4-4

CrownAdmin 3, troubleshooting 9-4

CrownNet Print Utility 6-2

Help 4-8

Online user's guide 4-8

Remote Console, accessing 3-2

Remote Console, closing 3-3

Remote Console, using 3-2

Troubleshooting CrownAdmin 3 9-4

**Windows Network**

See Microsoft Windows Network

**Workstation** G-11

Dedicated G-4

## **Z**

**Zone** G-11

EtherTalk, setting 4-4

Filters 4-6

HP Zoner Responder 2-20

Name, Zone Part 1 option 2-23

Name, Zone Part 2 option 2-23

Zone Name option 2-23

**Zone Name menu**

Default option 2-24

Zone Part 1 option 2-23

Zone Part 2 option 2-23

**Zone Name option** 2-23

**Zone Part 1 option** 2-23

**Zoner Responder, HP** 2-20



